

VOLVO  
**C70 PRICING**

**VOLVO**  
for life



# THE VOLVO C70

The rare combination of performance, precision and stability makes it easy to enjoy life behind the wheel of a Volvo C70 Convertible. The sense of freedom and exhilaration is never further away than the touch of a button combining the performance of three engines ranging between 163 bhp and 245 bhp and three generous specification levels. Unique safety solutions like our protection systems for side collisions, rear collisions and roll-over accidents make the Volvo C70 Convertible one of the world's safest open cars.

## T5

The T5 2.3 litre, turbocharged, in-line, 5 cylinder engine delivers outstanding performance – producing 245 bhp and 330 Nm torque. This extremely smooth engine features variable valve timing on the exhaust side and a responsive turbocharger designed to deliver maximum torque from low and medium engine speeds. Effortless performance and refinement are balanced with excellent fuel consumption.

## DOLBY SURROUND PRO LOGIC

The Volvo C70 was the first car in the world to be available with the Dolby Pro Logic Surround System™<sup>(ii)</sup>. The Pro Logic option adds an audio processor and a centre loudspeaker to the existing high performance sound system and delivers a 'wrap around' sound that transforms the car into a concert hall.

<b>CHOOSE YOUR VOLVO</b>	<b>2-3</b>
<b>STANDARD EQUIPMENT</b>	<b>4</b>
<b>OPTIONS</b>	<b>5</b>
<b>ACCESSORIES &amp; UPHOLSTERY</b>	<b>6-7</b>
<b>TECHNICAL SPECIFICATION</b>	<b>8-9</b>
<b>CHOOSE YOUR COLOUR</b>	<b>10</b>
<b>CARE BY VOLVO</b>	<b>11</b>

### C70

The comprehensive standard specification includes full electric soft top, glass rear screen, wind deflector, electronic climate control, full leather faced upholstery, 16" Zeus alloy wheels, cruise control and a 10-speaker CD player – not forgetting ROPS (Roll-Over Protection System), ABS, EBD and a full complement of front and side airbags.

	Basic £	VAT £	Rec Retail Price £	On The Road Price £	On The Road Price € <sup>(i)</sup> Euros
<b>PETROL</b> C70 2.0T	£20,595.74	£3,604.26	£24,200.00	£24,883.00	€36,105.23

### C70 COLLECTION

The C70 Collection Special Edition is sumptuously equipped with a choice of Toscana Tan or Off Black soft leather upholstery with heated seats. With a choice of 3 metallic paint colours as standard and unique 17" Otrera alloy wheels, this distinctive C70 delivers on style.

	Basic £	VAT £	Rec Retail Price £	On The Road Price £	On The Road Price € <sup>(i)</sup> Euros
<b>PETROL</b> C70 2.0T Collection	£22,042.55	£3,857.45	£25,900.00	£26,583.00	€38,571.93
C70 2.4T Collection	£23,489.36	£4,110.64	£27,600.00	£28,283.00	€41,038.63
C70 T5 Collection	£24,936.17	£4,363.83	£29,300.00	£29,983.00	€43,505.33

### C70 GT

The GT models offer enhanced specification including a comprehensive information centre, heated front seats, 3 x CD player with Dolby Pro Logic Surround System™<sup>(ii)</sup> and 17" Cratos alloy wheels.

	Basic £	VAT £	Rec Retail Price £	On The Road Price £	On The Road Price € <sup>(i)</sup> Euros
<b>PETROL</b> C70 2.0T GT	£22,042.55	£3,857.45	£25,900.00	£26,583.00	€38,571.93
C70 2.4T GT	£23,489.36	£4,110.64	£27,600.00	£28,283.00	€41,038.63
C70 T5 GT	£24,936.17	£4,363.83	£29,300.00	£29,983.00	€43,505.33



(i) Euro prices shown are for information only and are calculated using an exchange rate of 1.451 Euros to the £, as published in the Financial Times on 1st March 2005. Euro prices will be subject to the prevailing exchange rate at the time of purchase. These figures are for information purposes only.

(ii) Dolby and Pro Logic Surround Sound™ are trademarks of the Dolby Laboratories Licensing Corporation.

SAFETY & SECURITY	C70	COLLECTION	C70 GT
Driver and Passenger Airbags	•	•	•
SIPS (Side Impact Protection System)	•	•	•
SIPS Airbags	•	•	•
ROPS (Roll Over Protection System)	•	•	•
WHIPS (Whiplash Protection System) (Front Seats)	•	•	•
ABS (Anti-lock Brakes) with EBD (Electronic Brake Distribution)	•	•	•
STC (Stability and Traction Control)	•	•	•
4 Three Point Seat Belts	•	•	•
Seat Belt Pre-tensioners (Front)	•	•	•
Head Restraints – All 4 Seats	•	•	•
Anti-theft Alarm and Immobiliser	•	•	•
Remote Control Central Locking including Fuel Flap with Deadlocking System	•	•	•
Mass Movement Sensor	•	•	•
Tinted Windows	•	•	•
Visible VIN Plate	•	•	•
Day Running Lights	•	•	•
Headlamp Levelling System	•	•	•
High Level LED Brake Light	•	•	•
Home Safe Lighting	•	•	•
INTERIOR	C70	COLLECTION	C70 GT
ECC (Electronic Climate Control) and Pollen Filter	•	•	•
Exterior Temperature Gauge	•	•	•
Information Centre	•	•	•
Cruise Control	•	•	•
Front and Rear Power Windows	•	•	•
Power Adjustable and Heated Door Mirrors	•	•	•
Illuminated Driver and Passenger Vanity Mirrors	•	•	•
Front and Rear Reading Lamps	•	•	•
Autodimming Rear View Mirror	•	•	•
Front Cupholders	•	•	•
Height Adjustable Driver and Passenger Seats	•	•	•
Driver and Passenger Seat Mechanism for Access to Rear	•	•	•
Heated Front Seats	•	•	•
Front Centre Armrest	•	•	•
Leather Steering Wheel	•	•	•
Leather Sports Steering Wheel	•	•	•
Leather Handbrake Lever and Gear Knob	•	•	•
Height and Reach Adjustable Steering Column	•	•	•
Patterned Aluminium Trim (C70 Collection with Toscana Tan Soft Leather)	•	•	•
Carbon Fibre Trim (C70 Collection with Off Black Soft Leather Upholstery)	•	•	•
Leather-faced Upholstery	•	•	•
Soft Leather Upholstery (Toscana Tan or Off Black)	•	•	•
Luxury Floor Mats	•	•	•
SC-805 RDS Single Slot CD Stereo Radio Cassette, 4 x 60W Amplifier with Auto Sound Control	•	•	•
SC-901 RDS 3 x CD Radio Cassette, 4 x 100W Amplifier with	•	•	•
Dolby Pro Logic Surround Sound™(iii) and 9" Subwoofers Behind Rear Seat	•	•	•
EXTERIOR	C70	COLLECTION	C70 GT
16" Zeus Alloy Wheels – 225/50 ZR16 Tyres	•	•	•
17" Otrera Alloy Wheels – 225/45 ZR17 Tyres	•	•	•
17" Cratos Alloy Wheels – 225/45 ZR17 Tyres <sup>(iv)</sup>	•	•	•
Locking Wheels Nuts	•	•	•
Tempa Spare Wheel	•	•	•
Front Fog Lights	•	•	•
Headlamp Wash/Wipe	•	•	•
Comfort Chassis (2.0T/2.4T only)	•	•	•
Dynamic Chassis (T5 only)	•	•	•
Colour Co-ordinated Bumpers and Door Mirrors	•	•	•
Aluminium Sill Covers	•	•	•
Wind Deflector	•	•	•
Full Electric Soft Top (Black) with Glass Rear Screen	•	•	•



SAFETY & SECURITY	Basic £	VAT £	Rec Retail Price £	Rec Retail Price € <sup>(i)</sup>	C70	COLLECTION	C70 GT
Delete Passenger Airbag	–	–	–	–	nco	nco	nco
Inclination Sensor	£106.38	£18.62	£125.00	€181.38	o	o	o
INTERIOR	Basic £	VAT £	Rec Retail Price £	Rec Retail Price € <sup>(i)</sup>	C70	COLLECTION	C70 GT
Automatic Transmission	£936.17	£163.83	£1,100.00	€1,596.10	o	o	o
Information Centre	£272.34	£47.66	£320.00	€464.32	o	o	•
First Aid Kit	£21.28	£3.72	£25.00	€36.28	o	o	o
Power Driver and Passenger Seats (with Memory)	£936.17	£163.83	£1,100.00	€1,596.10	o	o	o
Heated Front Seats	£127.66	£22.34	£150.00	€217.65	o	•	•
Leather Sports Steering Wheel (Dark Grey)	£85.11	£14.89	£100.00	€145.10	o	•	nco
Red Wood/Leather Steering Wheel	£85.11	£14.89	£100.00	€145.10	o	n/a	nco
Red Wood Inlays/Red Wood Gear Knob (Gear Knob Auto only)	–	–	–	–	nco	n/a	nco
Soft Leather Upholstery	£297.87	£52.13	£350.00	€507.85	o	•	o
SC-901 RDS 3 x CD Stereo Radio Cassette (including 4 x 100W Amplifier)	£468.09	£81.91	£550.00	€798.05	o	o	nco
SC-901 RDS 3 x CD Stereo Radio Cassette, 4 x 100W Amplifier with Dolby Pro Logic Surround Sound™(iii) and 9" Subwoofers Behind Rear Seat	£978.72	£171.28	£1,150.00	€1,668.65	o	o	•
RTI Navigation System with UK Disc Map <sup>(iv)</sup>	£1,489.36	£260.64	£1,750.00	€2,539.25	o	o	o
EXTERIOR	Basic £	VAT £	Rec Retail Price £	Rec Retail Price € <sup>(i)</sup>	C70	COLLECTION	C70 GT
Black Paint (Solid)	£212.77	£37.23	£250.00	€362.75	o	n/a	o
Metallic/Pearlescent Paint <sup>(v)</sup>	£425.53	£74.47	£500.00	€725.50	o	•	o
16" Zeus Alloy Wheels – 225/50 ZR16 Tyres	–	–	–	–	•	n/a	nco
17" Comet Alloy Wheels – 225/45 ZR17 Tyres	£255.32	£44.68	£300.00	€435.30	o	nco	nco
17" Cratos Alloy Wheels – 225/45 ZR17 Tyres	£255.32	£44.68	£300.00	€435.30	o	nco	•
17" Propus Alloy Wheels – 225/45 ZR17 Tyres	£425.53	£74.47	£500.00	€725.50	o	u (£200)	u (£200)
Dynamic Chassis (Standard Height) (2.0T, 2.4T only)	£85.11	£14.89	£100.00	€145.10	o	o	o
Lowered Dynamic Chassis – (nco – T5)	£170.21	£29.79	£200.00	€290.20	o	o	o
Full Power Soft Top (Blue) with Glass Rear Screen	–	–	–	–	nco	n/a	nco



16" Zeus



17" Cratos



17" Propus



17" Comet



17" Otrera

CONVENIENCE PACK	Basic £	VAT £	Rec Retail Price £	Rec Retail Price € <sup>(i)</sup>	C70	COLLECTION	C70 GT
SC-901 RDS 3 x CD Radio Cassette, 4 x 100W Amplifier with Dolby Pro Logic Surround Sound™(iii), 9" Subwoofers Behind Rear Seat, Autodimming Rear View Mirror, Front Cupholders and Information Centre	£765.95	£134.05	£900.00	€1,305.90	n/a	o	•

• = standard, o = optional, nco = no cost option, u(£) = upgrade.

(i) Euro prices shown are for information only and are calculated using an exchange rate of 1.451 Euros to the £, as published in the Financial Times on 1st March 2005.

Euro prices will be subject to the prevailing exchange rate at the time of purchase. These figures are for information purposes only.

(ii) Dolby and Pro Logic Surround Sound™ are trademarks of Dolby Laboratories Licensing Corporation.

(iii) Cannot be ordered in conjunction with Dolby Pro Logic Surround Sound™(iii) – must be ordered with SC-901 RDS 3 x CD Stereo Radio Cassette.

(iv) The nco 16" alloy wheels will provide a more comfortable ride than the standard 17" alloy wheels.

(v) Volvo C70 Collection is available in Black Sapphire Metallic, Titanium Grey Pearl or Silver Metallic paint only.

ACCESSORIES	Basic £	VAT £	Rec Retail Price £	Rec Retail Price € <sup>(i)</sup>
<b>EXTERIOR ACCESSORIES (PRICES EXCLUDE FITTING UNLESS SHOWN OTHERWISE).</b>				
Load Carrier (boot lid)	£206.30	£36.10	£242.40	€351.72
Load Carrier Brake Lamp	£24.93	£4.36	£29.29	€42.50
<b>INTERIOR ACCESSORIES (PRICES EXCLUDE FITTING UNLESS SHOWN OTHERWISE).</b>				
Padded Neck Cushion	£22.74	£3.98	£26.72	€38.77
Warning Triangle	£20.37	£3.56	£23.93	€34.72
Hands-free Phone System <sup>(ii)(iii)</sup>	£287.96	£50.39	£338.35	€490.95

For further information and a complete list of all Volvo Accessories, just take a look at the new Accessory website at [www.volvocars.co.uk/accessories](http://www.volvocars.co.uk/accessories)

(i) Euro prices shown are for information only and are calculated using an exchange rate of 1.451 Euros to the £, as published in the Financial Times on 1st March 2005. Euro prices will be subject to the prevailing exchange rate at the time of purchase. These figures are for information purposes only.

(ii) Indicates total fitted price post registration. At participating dealers only.

(iii) Prices for this accessory start at this level.



## UPHOLSTERY

### LEATHER

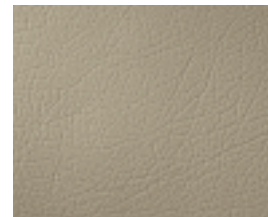

Light Beige (1966)



Granite (1944)



Grey (1970)

### SOFT LEATHER



Linen White (17B6)



Grey (1770)

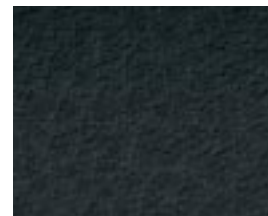

Off Black (1771)



Toscana Tan (17J0)

## INTERIOR INLAYS



Red Wood



Patterned Aluminium

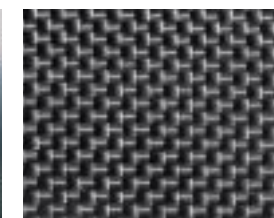

Carbon Fibre

## HOOD COLOUR

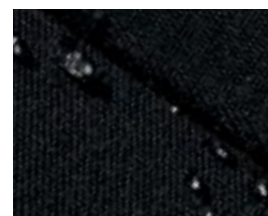

Black (standard)

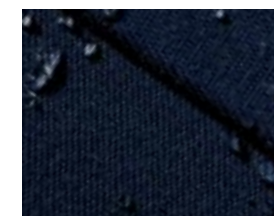

Navy Blue

NB It is not possible to reproduce exact original shades in printed matter.

ENGINE	2.0T	2.4T	T5
Configuration	Transverse 20 valve	Transverse 20 valve	Transverse 20 valve
Cylinders	5	5	5
Engine capacity, cc	1984	2435	2319
Bore x Stroke, mm	81 x 77	83 x 90	81 x 90
Max. output ECE, bhp kw rpm	163 120 5100	200 147 5700	245 180 5400
Max. torque ECE, Nm rpm	230 1800-5000	285 1800-5000	330 2400-5100
Octane rating	95-98 <sup>®</sup> RON unleaded	95-98 <sup>®</sup> RON unleaded	95-98 <sup>®</sup> RON unleaded
Fuel system	Multipoint Fuel Injection	Multipoint Fuel Injection	Multipoint Fuel Injection
Compression ratio	9.5:1	9.0:1	8.5:1

INSURANCE GROUPS	2.0T/2.0T GT	2.4T GT	T5 GT
Volvo C70 Convertible	15/16	17	18

WEIGHTS	All models
Min. kerb weight, kg (actual kerb weight dependent on spec.)	1565
Max. possible towing weight braked, kg	1600
Max. towing weight unbraked approx, kg <sup>(iv)</sup>	500
Max. total weight, kg	2020
Max. roof load, kg	N/A
Max. payload, kg (dependent on spec.)	455

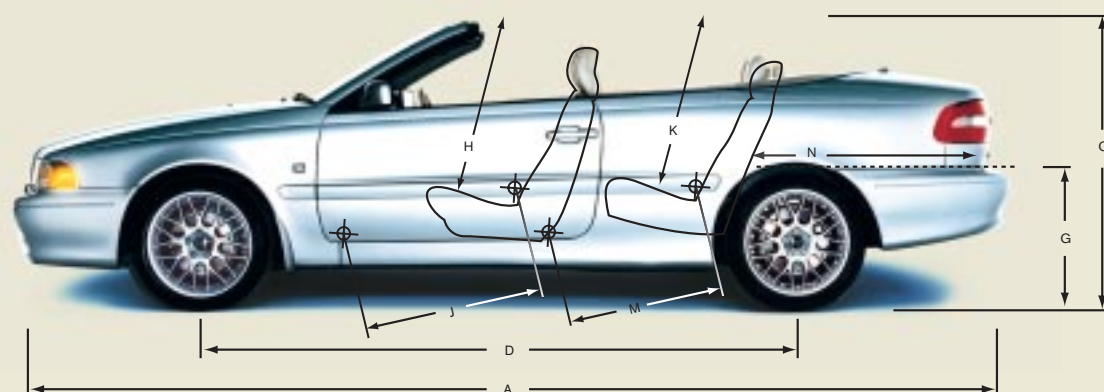

EXTERIOR (mm)		INTERIOR (mm)	
A Overall length	4716	H Front seat max. headroom	995
B Overall width (exc. wing mirrors)	1817	I Front seats width	1410
C Unladen height	1429	J Front seat max. legroom	1051
D Wheelbase length	2664	K Rear seat max. headroom	986
E Front track width	1521	L Rear seats width	1140
F Rear track width	1518	M Rear seat max. legroom	879
G Ground to boot base height	706	N Load length luggage 4 seat mode	820

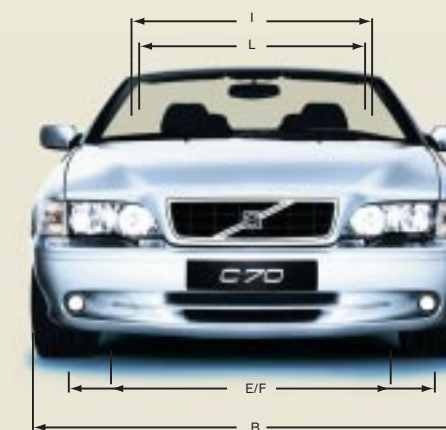

PERFORMANCE	2.0T		2.4T		T5	
	Man	Auto	Man	Auto	Man	Auto
Top speed, mph	130	124	137	130	149	143
Acceleration	9.9	10.7	8.5	9.0	7.5	8.0

TRANSMISSION	All models
Manual	5
Automatic	5

POWER STEERING SYSTEM	All models
(rack & pinion) Turning circle, m (ft)	11.7 (38'4")

FUEL CONSUMPTION <sup>(ii)</sup>	2.0T		2.4T		T5	
	Man	Auto	Man	Auto	Man	Auto
(Government Approved) Mpg (l/100km) <sup>(iii)</sup> Urban	20.9 (13.5)	18.1 (15.6)	20.6 (13.7)	17.7 (16.0)	20.6(13.7)	17.7 (16.0)
Extra Urban	38.2 (7.4)	36.7 (7.7)	36.7 (7.7)	35.3 (8.0)	36.7 (7.7)	35.3 (8.0)
Combined	29.1 (9.7)	26.6 (10.6)	28.5 (9.9)	25.9 (10.9)	28.5 (9.9)	25.9 (10.9)
CO <sub>2</sub> g/km	230	253	236	261	236	261
VED (Vehicle Excise Duty) Band	F	F	F	F	F	F

BRAKES	All models
Disc diameter mm, front	302 Ventilated
Disc diameter mm, rear	295

LUGGAGE COMPARTMENT	All models
Volume, litres (cu.ft)	223 (8.1)

PERFORMANCE	All models
Drag co-efficient	0.34

FUEL TANK	All models
Volume, litres (gallons)	68 (15.0)

- (i) For best performance and lowest fuel consumption 98 RON is recommended. 95 RON can be used for normal driving.
- (ii) The Urban fuel consumption figure is based on typical city driving, including starting the car from cold. The Extra Urban figure is based on typical motorway driving and cruising. The Combined figure averages the consumption across both cycles.
- (iii) These results do not express or imply any guarantee of the fuel consumption of a particular car as there are inevitable differences between individual cars of the same model. Additionally driving style, traffic conditions, as well as the age and mileage and standard of maintenance will affect a car's fuel consumption.
- (iv) Unbraked towing weight must not exceed 50% of kerb weight up to a maximum of 750 kg.

**Notes**  
The weight of the vehicle will influence the level of CO<sub>2</sub> emitted. As a result, vehicles with higher levels of specification and factory fit options may emit higher levels of CO<sub>2</sub>. Once a vehicle has been built it will be given its own specific CO<sub>2</sub> emission on which the Vehicle Excise Duty will be charged. A weighbridge must be used to determine specific weights. Data valid for manual transmission unless specified. All measurements in mm. NB Some of the information in this price list may not be correct due to product changes which may have occurred since it was printed. Some of the equipment described or shown may now be available only at extra cost. Before ordering, please ask your Volvo dealer for the latest information. The manufacturer reserves the right to make changes at any time, without notice, to prices, colour, materials, specifications and models. Volvo Car UK Limited, Globe Park, Marlow, Buckinghamshire, SL7 1YQ



019 Black Stone



452 Black Sapphire metallic



417 Nautic Blue pearl



455 Titanium Grey pearl



426 Silver metallic



461 Sky Blue pearl



443 Moondust metallic



612 Passion Red



**CARE**  
BY VOLVO

## THE END IS JUST THE BEGINNING

It's a simple idea; one point of contact for all your car ownership needs – whether it's about finding the right finance deal or who to contact in an emergency. To get the most out of owning your Volvo, trust Care by Volvo.

### STARTING OFF ON THE RIGHT FOOT

You might be surprised how easy and flexible financing can be. Our range of finance, service and insurance options allows you to budget around one key factor – your lifestyle.

### FINANCE/LEASE

As part of Volvo, Volvo Car Finance has developed a series of funding plans that will provide you with maximum choice and flexibility when acquiring a Volvo.

### INSURANCE

Volvo Owners Insurance is designed for Volvo drivers and because we know Volvos inside out, we can offer exactly the right tools and expertise, fitting only genuine Volvo parts by trained Volvo technicians. Because Volvo drivers have an excellent reputation, we can also offer extensive cover at a reasonable price.

Call now for your insurance quote on **0800 238 239<sup>0</sup>**, quoting reference BROCH.

### MAKING LIFE EASIER

Owning a Volvo should be a safe and enjoyable experience. To ensure it stays that way, we're committed to providing you with the best in support for as long as you own one.

### SERVICE PROGRAMME

Your Volvo dealer has the unique know-how to tailor a service programme according to Volvo's strict recommendations and guarantees you years of safety and driving pleasure.

### LOOKING AHEAD

You'll probably never find out just how good some of these services are. But should the unexpected happen, we'd like to think that you'd be even happier you chose a Volvo.

### ROADSIDE ASSISTANCE

Every new car comes with one year's free RAC cover. You'll enjoy full breakdown and recovery assistance, anywhere in Europe, 24 hours a day. You can even extend cover for up to two more years at preferential rates.

### WARRANTY

Every new Volvo comes with comprehensive protection. Our warranty covers the first three years or 60,000 miles, whichever comes first. There's a three year unlimited warranty on the paintwork, and either eight or twelve years against rust perforation. If a component fails due to a defect or material fault, your dealer will swiftly rectify the problem, free of charge.

For tax free sales, including Military, Diplomat and all other Export enquiries, contact Volvo Car UK Tourist & Diplomat Sales or Volvo Car UK British Military Sales on **01707 262 388** or e-mail to [vcukics@volvocars.com](mailto:vcukics@volvocars.com) or [bms@volvocars.com](mailto:bms@volvocars.com)

**WHAT NEXT?** If you'd like to find out more about the range of products and services that make up Care by Volvo, the story continues at [www.volvocars.co.uk](http://www.volvocars.co.uk) Alternatively you can contact your nearest Volvo dealer or request relevant brochures.

(i) Volvo Owners Insurance is underwritten by Royal & Sun Alliance Insurance plc No. 93792. Registered in England and Wales at St Mark's Court, Chart Way, Horsham, West Sussex RH12 1XL. Authorised and regulated by the Financial Services Authority. For your protection telephone calls will be recorded and may be monitored.

**NB** Some of the information in this brochure may not be correct due to product changes which may have occurred since it was printed. Before ordering, please ask your Volvo dealer for the latest information. The manufacturer reserves the right to make changes at any time, without notice, to prices, colour, materials, specifications and models.



**VOLVO**

Volvo Car UK Limited  
[www.volvocars.co.uk](http://www.volvocars.co.uk)