

VOLVO XC90

PRICE AND SPECIFICATION



Create your perfect Volvo XC90

Congratulations. You're only a few steps away from your perfect Volvo XC90. This price list contains everything you need to create the car that's exactly right for you.

From selecting the right package and choosing from a range of class leading engines, through to picking the perfect colour and adding the finishing touches, you're in complete control. You'll also find full engine details and in-depth technical specifications to help you make the most informed choice.

Whatever you decide, you'll be choosing a next generation SUV (Sports Utility Vehicle). With outstanding passenger comfort for up to 7, excellent fuel consumption, advanced All Wheel Drive and stunning good looks, the Volvo XC90 has surpassed all expectations of what an SUV should be.





XC90 S

The S model comes with all the features you'd expect from a Volvo. Beyond the 17" Antaeus alloy wheels and RSC (Roll Stability Control) system, the S offers dual-zone climate control, Rear Park Assist and power door mirrors and windows. Interior details include a leather steering wheel and gear knob, and our High Performance audio system with 8 speakers and CD player.

XC90 SE

The SE takes you and your passengers further along the path of self-indulgence with leather-faced upholstery, dark wood trim and a power adjustable driver's seat. There's a CD player and various intuitive features, such as the automatic rain sensor and autodimming rear-view mirror with compass. On the outside, 18" Atlantis alloy wheels make sure you don't go unnoticed.

XC90 SE LUX

The SE Lux includes the ultimate motoring equipment. Above and beyond SE specification, the SE Lux has Chronograph instrument dials, Sovereign Hide Soft Leather upholstery, Sapeli wood trim and both front seats are powered and heated. Further comforts include luxury floor mats and autofolding power door mirrors with ground lights. Exterior details include 18" Camulus alloy wheels, brushed aluminium roof rails and Active Bending headlamps with power washers.

XC90 EXECUTIVE

The Executive is the ultimate in Volvo luxury. Its refined exterior boasts stylish body-coloured door mirrors and rubbing strips, Active Bending headlamps and 19" Galateia alloy wheels are further highlights. Inside the cabin, inlays of walnut provide a warm welcome, while Executive Ventilated Soft Leather upholstery with massage function, extra padding and armrests pamper. Further features include a fridge, RTI navigation system, and our Dynaudio Premium Sound audio with Dolby Pro Logic II Surround Sound⁽¹⁾.

XC90 *R*DESIGN

The R-DESIGN model combines the luxury features of the SE, with sports styling and handling enhancements. Speed dependent power steering with unique 19" Vulcanis alloy wheels and R-DESIGN chassis enhance the handling. Visual presence is further enhanced with silver matt door mirrors, unique quad tail pipes, together with R-DESIGN leather-faced upholstery, front sports seats with side support, R-DESIGN leather steering wheel and unique aluminium interior trim.

⁽¹⁾ Dolby and Pro Logic Surround Sound™ are trademarks of Dolby Laboratories Licensing Corporation.

On the road

How much will it cost to get behind the wheel of your own Volvo XC90? Simply decide which model variant and engine type are right for you and then take a look at the full price list below.

XC90 S

	Basic £	VAT £	Rec Retail Price £	On the Road Price £
DIESEL				
D5 AWD (185 PS) S	£27,404.26	£4,795.74	£32,200.00	£32,995.00

XC90 SE

	Basic £	VAT £	Rec Retail Price £	On the Road Price £
PETROL				
3.2 AWD (238 PS) SE Geartronic	£30,736.17	£5,378.83	£36,115.00	£37,100.00
DIESEL				
D5 AWD (185 PS) SE	£29,872.34	£5,227.66	£35,100.00	£35,895.00



XC90 SE LUX

	Basic £	VAT £	Rec Retail Price £	On the Road Price £
PETROL				
3.2 AWD (238 PS) SE Lux Geartronic	£32,523.40	£5,691.60	£38,215.00	£39,200.00
V8 AWD (315 PS) SE Lux Geartronic	£39,246.81	£6,868.19	£46,115.00	£47,100.00
DIESEL				
D5 AWD (185 PS) SE Lux	£31,659.57	£5,540.43	£37,200.00	£37,995.00

XC90 EXECUTIVE

	Basic £	VAT £	Rec Retail Price £	On the Road Price £
PETROL				
3.2 AWD (238 PS) Executive Geartronic	£39,331.91	£6,883.09	£46,215.00	£47,200.00
V8 AWD (315 PS) Executive Geartronic	£46,055.32	£8,059.68	£54,115.00	£55,100.00
DIESEL				
D5 AWD (185 PS) Executive Geartronic	£39,659.57	£6,940.43	£46,600.00	£47,395.00

XC90 R-DESIGN

	Basic £	VAT £	Rec Retail Price £	On the Road Price £
PETROL				
3.2 AWD (238 PS) R-DESIGN Geartronic	£32,225.53	£5,639.47	£37,865.00	£38,850.00
V8 AWD (315 PS) R-DESIGN Geartronic	£38,948.94	£6,816.06	£45,765.00	£46,750.00
DIESEL				
D5 AWD (185 PS) R-DESIGN	£31,361.70	£5,488.30	£36,850.00	£37,645.00

The right equipment

It's essential that your Volvo comes equipped with everything you need. Below you'll find the standard equipment lists for each model variant, plus optional equipment to personalise your Volvo XC90. And as you'd expect, there is an array of industry-leading, cutting edge safety innovations.

STANDARD EQUIPMENT - SAFETY & SECURITY	S	SE	SE LUX	EXECUTIVE	R-DESIGN
Dual Stage Driver and Passenger Airbags	•	•	•	•	•
SIPS (Side Impact Protection System)	•	•	•	•	•
SIPS Airbags	•	•	•	•	•
IC (Inflatable Curtain)	•	•	•	•	•
RSC (Roll Stability Control)	•	•	•	•	•
WHIPS (Whiplash Protection System) (Front Seats)	•	•	•	•	•
ABS (Anti-lock Brake System) with EBD (Electronic Brake Distribution)	•	•	•	•	•
DSTC (Dynamic Stability and Traction Control) with Electronic Brake Assistance	•	•	•	•	•
7 Three Point Seat Belts	•	•	•	•	•
Seat Belt Pre-tensioners (All Seats)	•	•	•	•	•
Head Restraints - All 7 Seats	•	•	•	•	•
ISOFIX Child Seat Preparation (2nd Row)	•	•	•	•	•
Integrated Booster Cushion (2nd Row)	•	•	•	•	•
Anti-theft Alarm including Immobiliser with LED (Key Transponder) and Level Sensor	•	•	•	•	•
Key Integrated Remote Control Central Locking including Fuel Flap with Deadlocking System	•	•	•	•	•
Mass Movement Sensor	•	•	•	•	•
Water Repellent Front Side Windows	•	•	•	•	•
Load Cover (Cargo Area) and Load Protection Net	•	•	•	•	•
Day Running Lights	•	•	•	•	•
Headlamp Levelling System	•	•	•	•	•
High Level LED Brake Light	•	•	•	•	•
Home Safe and Approach Lighting	•	•	•	•	•

STANDARD EQUIPMENT - EXTERIOR	S	SE	SE LUX	EXECUTIVE	R-DESIGN
Metallic Paint				•	
17" Antaeus Alloy Wheels - 235/65 R17 Tyres	•				
18" Atlantis Alloy Wheels - 235/60 R18 Tyres		•			
18" Camulus Alloy Wheels - 235/60 R18 Tyres			•		
19" Galateia Alloy Wheels - 255/50 R19 Tyres				•	
19" Vulcanis 5-Spoke Alloy Wheels (Silver Bright) - 255/50 R19 Tyres					•
Locking Wheel Nuts	•	•	•	•	•
Tyre Sealant Kit and 12V Compressor	•	•	•	•	•
Active Bending Headlamps with Headlamp Cleaning System				•	•
Power Folding Door Mirrors with Ground Lights		•	•	•	•
Power Adjustable and Heated Door Mirrors	•	•	•	•	•
Front Fog Lights	•	•	•	•	•
Rear Wash/Wipe with Interval Function	•	•	•	•	•
Rain Sensor - Automatic Windscreen Wiper Activation		•	•	•	•
Roof Rails (Brushed Aluminium - SE Lux/Executive Only)	•	•	•	•	•
Comfort Chassis	•	•	•	•	•
R-DESIGN Lowered Sports Chassis					•
Towbar Preparation	•	•	•	•	•
Colour Co-ordinated Door Mirrors (Matt Chrome - Executive)	•	•	•	•	•
R-DESIGN Silver Matt Door Mirrors					•
Colour Co-ordinated Wheel Arches		•	•	•	•
Extended Colour Co-ordinated Wheel Arches					•
Front and Rear Skidplate (Unique Rear Skidplate - R-DESIGN)	•	•	•	•	•
Colour Co-ordinated Door Handles and Rubbing Strips	•	•	•	•	•
Unique Executive Grille				•	•
Chrome Surround for Air Intake (V8 AWD Only)		•	•	•	•
R-DESIGN Grille with Logo					•
Silver Matt Exterior Trim (Window Frame Surround, Tailgate Trim and Side Scuff Plates)					•
Silver Extended Front Skidplate and Unique Rear Skidplate					•
Rear Park Assist	•	•	•	•	•
Exterior Executive Badge				•	•
Chromed Stainless Steel Sports Quad Tail Pipes					•
Executive Chromed C Pillar				•	•
Load Compensating Suspension	•	•	•	•	•
Electronic All Wheel Drive System with Instant Traction™ (Haldex Coupling)	•	•	•	•	•

STANDARD EQUIPMENT - INTERIOR	S	SE	SE LUX	EXECUTIVE	R-DESIGN
ECC (Electronic Climate Control) with AQS (Air Quality System) and Pollen Filter	•	•	•	•	•
B Pillar Ventilation	•	•	•	•	•
Information Centre	•	•	•	•	•
Exterior Temperature Gauge	•	•	•	•	•
Cruise Control	•	•	•	•	•
Geartronic Transmission (6 speed) (Standard 3.2 AWD and V8 AWD Only)		•	•	•	•
Speed Dependent Steering System (Standard V8 AWD Only)		•	•	•	•
Speed Dependent Sports Steering System					•
Front and Rear Power Windows	•	•	•	•	•
Illuminated Driver and Passenger Vanity Mirrors	•	•	•	•	•
Front and Rear Reading Lights	•	•	•	•	•
Autodimming Rear View Mirror	•				•
Autodimming Rear View Mirror with Compass		•	•	•	•
Front Centre Armrest	•	•	•	•	•
Cupholders in Tunnel Console - Front and Rear	•	•	•	•	•
Grocery Bag Holder		•	•	•	•
12V Socket (Rear Tunnel Console/Luggage Area)	•	•	•	•	•
Power Driver's Seat with Memory and Door Mirror Memory		•			•
Power Driver and Passenger Seats with Driver's Memory and Door Mirror Memory			•	•	•
Heated Front Seats				•	•
Height Adjustable Driver and Passenger Seats	•	•	•	•	•
Forward Folding Front Passenger Seat	•	•	•	•	•
2 Individual Folding 3rd Row Seats	•	•	•	•	•
3 Individual Folding 2nd Row Seats	•	•	•	•	•
Leather Steering Wheel	•	•	•	•	•
Leather Gear Knob	•	•	•		
R-DESIGN Leather Sports Steering Wheel with Logo					•
R-DESIGN Sports Gear Knob					•
Steering Wheel Remote Audio Controls	•	•	•	•	•
Chronograph Instrument Dials			•	•	•
R-DESIGN Unique Instrument Dials					•
Height and Reach Adjustable Steering Column	•	•	•	•	•
Illuminated Ignition Lock	•	•	•	•	•
Manganite Trim	•				
Dark Wood Trim		•			
Sapeli Wood Trim			•		
Walnut Wood Trim in Panels, Centre Console and Gear Lever Knob				•	
R-DESIGN Rubber/Aluminium Trim					•
Marstrand Textile/Vinyl Upholstery	•				
Leather-faced Upholstery		•			
Sovereign Hide Soft Leather Upholstery			•		
Executive Ventilated Soft Leather Upholstery with Massage Function and Door Inserts with Contrast Piping (All 3 Rows)				•	
R-DESIGN Leather-faced Sports Upholstery with Logo					•
Executive Soft Leather Extra Padded Front Door Armrests				•	
Luxury Floor Mats			•		
Executive Nubuck Trimmed Floor Mats				•	
R-DESIGN Sports Floor Mats					•
R-DESIGN Aluminium Sports Pedals					•
High Performance Audio System - 1 x CD/Radio, 4 x 40W Amplifier, Aux Input (MP3/WMA Compatible) Amplifier and 8 Speakers	•	•	•		•
Dynaudio Premium Sound Audio System - 6 x CD/Radio with Dolby Pro Logic II ⁽ⁱ⁾ Digital Surround Sound, 5 x 130W Amplifier, Aux Input (MP3/WMA Compatible) and 12 Speakers				•	
Rear Seat Audio Console with Headphone Sockets x4				•	
RTI Navigation System with RDS-TMC, Remote Control and Map Data on Hard Disk				•	
Volvo On Call ⁽ⁱⁱ⁾				•	
Dual Band Integrated GSM Telephone				•	
Refrigerator in Front Centre Armrest ⁽ⁱⁱⁱ⁾				•	

(i) Dolby and Pro Logic Surround Sound™ are trademarks of Dolby Laboratories Licensing Corporation.
(ii) Volvo On Call includes Safety Package (Security Package available at extra cost).
(iii) Front Centre Armrest cannot be removed on XC90 Executive.

OPTIONAL EQUIPMENT – SAFETY & SECURITY	Basic £	VAT £	Rec Retail Price £	S	SE	SE LUX	EXECUTIVE	REDESIGN
BLIS (Blind Spot Information System) with Power Folding Door Mirrors	£553.19	£96.81	£650.00	o	u (£450)	u (£450)	u (£450)	u (£450)
Passenger Airbag Cut Off Switch	£21.28	£3.72	£25.00	o	o	o	o	o
Dark Tinted Rear Windows (Rear Windows and Rear Screen) ⁽ⁱ⁾	£297.88	£52.12	£350.00	o	o	o	o	o
Laminated Water Repellent Side Windows ⁽ⁱ⁾	£331.91	£58.09	£390.00	o	u (£300)	u (£300)	o	u (£300)
IR (Infrared) Reflective Glass Windscreen and Front Windows	£208.51	£36.49	£245.00	o	o	o	o	o
Power Child Locks (Rear Doors)	£127.66	£22.34	£150.00	o	o	o	o	o
Homelink	£42.55	£7.45	£50.00	o	o	o	o	o
First Aid Kit	£21.28	£3.72	£25.00	o	o	o	o	o

OPTIONAL EQUIPMENT – EXTERIOR	Basic £	VAT £	Rec Retail Price £	S	SE	SE LUX	EXECUTIVE	REDESIGN
Black Paint (Solid)	£212.77	£37.23	£250.00	o	o	o	n/a	n/a
Metallic/Pearlescent Paint	£510.64	£89.36	£600.00	o	o	o	•	o
Inscription™ Paint	£702.13	£122.87	£825.00	o	o	o	u (£250)	o
17" Neptune Alloy Wheels – 235/65 R17 V Tyres	–	–	–	nco	nco	nco	n/a	n/a
18" Atlantis Alloy Wheels – 235/60 R18 V Tyres	£510.64	£89.36	£600.00	o	•	nco	n/a	n/a
18" Situla Alloy Wheels – 235/60 R18 Tyres	£510.64	£89.36	£600.00	o	nco	nco	n/a	n/a
18" Atlantis Alloy Wheels (Polished) – 235/60 R18 V Tyres	£702.13	£122.87	£825.00	o	u (£225)	u (£225)	n/a	n/a
18" Atlantis Alloy Wheels (Chromed) – 235/60 R18 V Tyres	£1,268.09	£221.91	£1,490.00	o	u (£890)	u (£890)	n/a	n/a
18" Camulus Alloy Wheels – 235/60 R18 V Tyres	£510.64	£89.36	£600.00	o	nco	•	n/a	n/a
19" Vulcanis 5-Spoke Diamond Cut Alloy Wheels (Light Titanium) – 255/50 R19 Tyres	–	–	–	n/a	n/a	n/a	n/a	nco
20" Cratus Alloy Wheels – 255/45 R20 Tyres	£425.53	£74.47	£500.00	n/a	n/a	n/a	n/a	o
Tempa Spare Wheel ⁽ⁱⁱ⁾	–	–	–	nco	nco	nco	nco	n/a
Power Folding Door Mirrors with Ground Lights	£170.21	£29.79	£200.00	o	•	•	•	•
Rain Sensor – Automatic Windscreen Wiper Activation	£123.40	£21.60	£145.00	o	•	•	•	•
Brushed Aluminium Roof Rails	–	–	–	n/a	n/a	•	•	nco

• = Standard, o = option, n/a = not available, nco = no cost option i.e. a customer can upgrade to that option without paying any extra money, u = upgrade, i.e. a customer can upgrade to that option but will pay the difference in price, upgrade price shown in (£).

(i) Laminated Water Repellent Side Windows and Dark Tinted Rear Windows cannot be combined.

(ii) Electric Glass Tilt and Slide Sunroof cannot be combined with Tempa Spare Wheel on D5 Executive Geartronic.

(iii) Cannot be ordered on D5 Manual.

(iv) Cannot be combined with Cross Brushed Aluminium Trim.

(v) Dolby and Pro Logic II Surround Sound™ are trademarks of Dolby Laboratories Licensing Corporation.

(vi) If Dynaudio Premium Sound Audio ordered with RTI Navigation System or Communications Pack, system includes 11 speakers.

(vii) Must be ordered in conjunction with Rear Seat Entertainment

(viii) Volvo On Call includes Safety package (Security package available at additional cost).



OPTIONAL EQUIPMENT – INTERIOR	Basic £	VAT £	Rec Retail Price £	S	SE	SE LUX	EXECUTIVE	REDESIGN
Geartronic Transmission (Standard 3.2 AWD and V8 AWD)	£1,191.49	£208.51	£1,400.00	o	o	o	•	o
Speed Dependent Steering System (Standard V8 AWD)	£191.49	£33.51	£225.00	o	o	o	•	n/a
Air Conditioning for 3rd Row of Seats ⁽ⁱⁱⁱ⁾	£314.89	£55.11	£370.00	o	o	o	o	o
Power Glass Tilt and Slide Sunroof ⁽ⁱⁱ⁾	£723.40	£126.60	£850.00	o	o	o	o	o
Autodimming Rear View Mirror with Compass	£42.55	£7.45	£50.00	o	•	•	•	•
Grocery Bag Holder	£85.11	£14.89	£100.00	o	•	•	•	•
Front and Rear Ashtray with Cigarette Lighter	–	–	–	nco	nco	nco	nco	nco
Power Driver's Seat with Memory and Door Mirror Memory	£510.64	£89.36	£600.00	o	•	n/a	n/a	•
Power Driver and Passenger Seats with Driver's Memory and Door Mirror Memory	£1,021.28	£178.72	£1,200.00	o	u (£600)	•	•	u (£600)
Sapeli Leather Steering Wheel, Gear Knob (Geartronic Only) ^(iv)	£204.26	£35.74	£240.00	o	o	o	n/a	n/a
Cross Brushed Aluminium Trim	£212.77	£37.23	£250.00	o	nco	nco	nco	n/a
Sapeli Wood Trim ^(v)	£425.53	£74.47	£500.00	o	nco	•	n/a	n/a
Inscription™ Black Walnut Wood Trim (only available with Inscription™ Soft Leather Upholstery)	£127.66	£22.34	£150.00	n/a	o	o	n/a	n/a
Leather-faced Upholstery	£851.06	£148.94	£1,000.00	o	•	n/a	n/a	n/a
Inscription™ Soft Leather Upholstery, Door Panels, Sports Leather Steering Wheel, Luxury Floor Mats (All 3 Rows) with Piping and Inscription™ Treadplates	£1,923.40	£336.60	£2,260.00	n/a	o	u (£1,300)	n/a	n/a
6 x CD Player	£212.77	£37.23	£250.00	o	o	o	•	o
Dynaudio Premium Sound Audio System – 6 x CD/Radio with Dolby Pro Logic II ^(vi) Digital Surround Sound, 5 x 130W Amplifier, Aux Input (MP3/WMA Compatible) and 12 Speakers ^(vii)	£851.06	£148.94	£1,000.00	n/a	o	o	•	o
Rear Seat Entertainment System with 1 x DVD player in Front Centre Armrest, 2 x 8" Screens, 2 x IR Headphones, Remote Control and Dark Tinted Rear Windows (Rear Windows and Rear Screen)	£1,148.94	£201.06	£1,350.00	n/a	o	o	o	o
Rear Seat Audio Console with Headphone Sockets x 4	£80.85	£14.15	£95.00	o	o	o	•	o
Digital TV ^(viii)	£340.43	£59.57	£400.00	n/a	o	o	o	o
RTI Navigation System with RDS-TMC, Remote Control and Map Data on Hard Disk ^(vii)	£1,574.47	£275.53	£1,850.00	o	o	o	•	o
Dual Band Integrated GSM Telephone and Volvo On Call ^(viii)	£680.85	£119.15	£800.00	o	o	o	•	o

	Basic £	VAT £	Rec Retail Price £	S	SE	SE LUX	EXECUTIVE	REDESIGN
WINTER PACK								
Heated Front Seats, Headlamp Cleaning System and Luxury Floor Mats	£340.43	£59.57	£400.00	o	o	n/a	n/a	u (£250)
Upgrade for Inscription™ SE	£259.57	£45.43	£305.00	n/a	o	n/a	n/a	n/a
Winter Pack with Active Bending Headlamps	£851.06	£148.94	£1,000.00	o	o	•	•	n/a
Upgrade for Inscription™ SE	£680.85	£119.15	£800.00	n/a	o	n/a	n/a	n/a
COMMUNICATIONS PACK^(vi)								
Dual Band Integrated GSM Telephone with Handset and Volvo On Call ^(viii) , RTI Navigation System with RDS-TMC and Map Data on Hard Disk	£2,170.21	£379.79	£2,550.00	o	o	o	•	o
ENTERTAINMENT SUPPORT PACK								
RTI Navigation System with RDS-TMC, Remote Control and Map Data on Hard Disk ^(vii) , BLIS (Blind Spot Information System) and Rear Seat Entertainment with 1 x DVD Player in Front Centre Armrest, 2 x 8" Screens, 2 x IR Headphones, Remote Control and Dark Tinted Windows (Rear Windows and Rear Screen)	£2,425.53	£424.47	£2,850.00	n/a	o	o	u (£1,350)	o



What's your style?

At Volvo we know everyone is different. And that's why you can choose from a whole spectrum of colours for the exterior of your Volvo XC90. Whatever your style, you'll find the perfect shade for you.



426 Silver metallic



454 Ruby Red pearl⁽ⁱ⁾



472 Oyster Grey pearl⁽ⁱ⁾



480 Shadow Blue pearl⁽ⁱ⁾



493 Caper Green pearl



452 Black Sapphire metallic⁽ⁱⁱ⁾⁽ⁱⁱⁱ⁾



455 Titanium Grey pearl⁽ⁱ⁾⁽ⁱⁱ⁾



473 Shimmer Gold pearl



487 Inscription™ Ember Black pearl⁽ⁱ⁾



612 Passion Red^(iv)

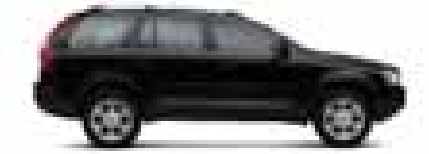

019 Black Stone

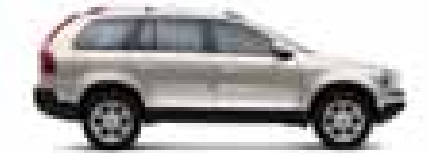

453 Inscription™ White pearl⁽ⁱⁱⁱ⁾



467 Magic Blue pearl⁽ⁱ⁾⁽ⁱⁱ⁾



477 Inscription™ Electric Silver Coarse Flake metallic⁽ⁱ⁾⁽ⁱⁱ⁾

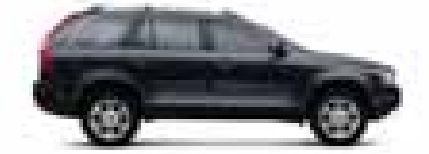

492 Savile Grey pearl



614 Ice White⁽ⁱⁱ⁾

⁽ⁱ⁾ XC90 Executive only available with these colours. ⁽ⁱⁱ⁾ XC90 R-DESIGN only available with these colours. ⁽ⁱⁱⁱ⁾ Exclusive to XC90 Executive. ^(iv) Exclusive to XC90 R-DESIGN.

NB It is not possible to reproduce exact original shades in printed matter. Please ask your Volvo dealer to show you samples.

The wheels

And now we come to one of the most important parts of choosing your new Volvo XC90. Volvo alloy wheels come in a variety of different styles, cuts and finishes – each with its own distinct character.

Your selection of alloy wheel can dramatically influence the exterior styling of your Volvo XC90. What will you choose?

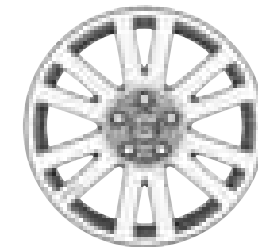

17" Antaeus

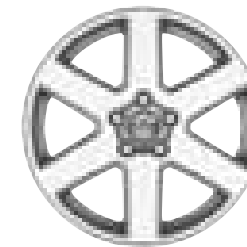

17" Neptune

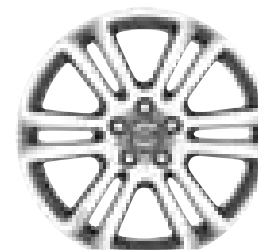

18" Camulus

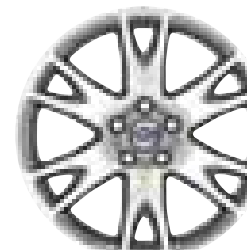

18" Atlantis (Silver Bright, Polished or Chromed)

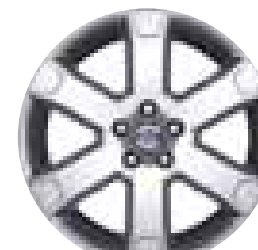

18" Situla

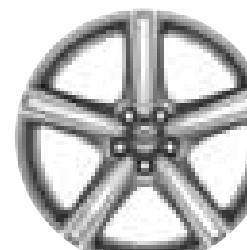

19" Vulcanis (Silver Bright or Diamond Cut Light Titanium)

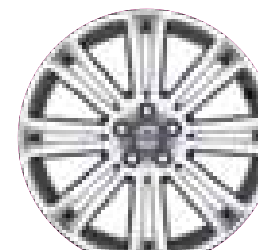

19" Galateia (Diamond Cut Light Titanium)



20" Cratus

Bespoke tailoring from Volvo

The finest fabrics, superb stitching and minute attention to detail – whichever interior you choose for your Volvo XC90 you'll be surrounded by luxury. How will you tailor yours?

R-DESIGN LEATHER-FACED SPORTS



Off Black with Cream Inlay (CBSB)



Calcite with Off Black Inlay (CBQJ)

MARSTRAND TEXTILE/VINYL

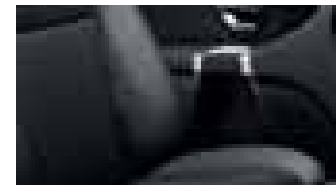

Off Black (C000)



Soft Beige (C010)

LEATHER-FACED



Off Black (C900)



Calcite (C90T)



Quartz (C950)



Soft Beige (C910)

SOVEREIGN HIDE SOFT LEATHER



Off Black (C700)



Chestnut (C70R)



Calcite (C70T)



Soft Beige (C710)

EXECUTIVE VENTILATED SOFT LEATHER



Off Black (CU00)



Soft Beige (CU10)

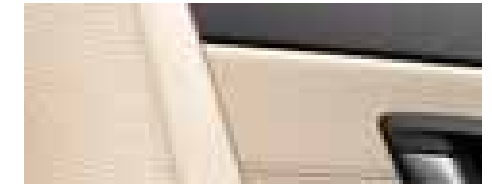

Soft Beige (CUSU)

Interior inlays

A selection of premium materials to complement your interior fabric.



Manganite



Dark Wood

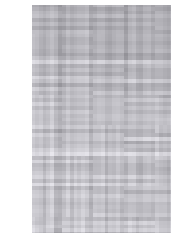

Cross Brushed
Aluminium



Sapeli Wood



Walnut Wood
(Executive Only)

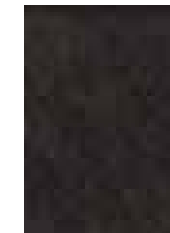

Black Walnut Wood
(Inscription™ Only)

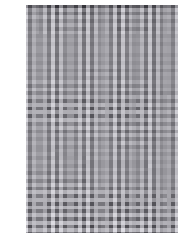

R-DESIGN
Rubber/Aluminium
Trim

UPHOLSTERY	Upholstery Code	Upholstery Colour	Dashboard Top/ Door Panel Colour	Door Insert Colour	Headliner Colour
Marstrand Textile/Vinyl	C000 C010	Off Black Soft Beige	Off Black/Off Black Espresso Brown/Mocca Brown	Off Black Soft Beige	Quartz Soft Beige
Leather-faced	C900 C90T C950 C910	Off Black Calcite Quartz Soft Beige	Off Black/Off Black Off Black/Off Black Dark Umbra/Umbra Espresso Brown/Mocca Brown	Off Black Calcite Quartz Soft Beige	Quartz Quartz Quartz Soft Beige
R-DESIGN Sports Leather-faced	CBSB CBQJ	Off Black with Cream Inlay Calcite with Off Black Inlay	Off Black/Off Black Off Black/Off Black	Off Black Off Black	Quartz Quartz
Sovereign Hide Soft Leather	C700 C70R C70T C710	Off Black Chestnut Calcite Soft Beige	Off Black/Off Black Off Black/Off Black Off Black/Off Black Espresso Brown/Mocca Brown	Off Black Chestnut Calcite Soft Beige	Quartz Quartz Quartz Soft Beige
Executive Ventilated Soft Leather	CU00 CUSU CU10	Off Black Soft Beige Soft Beige	Off Black/Off Black Off Black/Off Black Mocca Brown/Mocca Brown	Off Black Soft Beige Soft Beige	Quartz Quartz Soft Beige

NB It is not possible to reproduce exact original shades in printed matter.

NB For full colour breakdown of upholstery and interior, please refer to the upholstery section on the next page.

Inscription

Volvo Inscription™ opens up a whole new colourful world of interior sophistication for you to discover. Choose from a collection of exquisite, specially designed interiors available in a kaleidoscope of colours and put your own personal signature on your Volvo.

Once you've colour co-ordinated the finest Scottish hide leather upholstery, carpets, steering wheel, panel trims and matching floor mats, you'll have created an in-car experience your senses won't let you forget.

To help you decide, our Design Team have suggested the best possible colour combinations for interior and exterior shown in the Designer's Recommendations section.

Inscription™. Designed by Volvo, inscribed by you.



CH7F

UPHOLSTERY AND INTERIOR COLOURS
Marquis Red/Off Black Inscription™ Soft Leather with Marquis Red stitching. Off Black interior with Granite headliner and Off Black Luxury Floor Mats with Marquis Red piping.

DESIGNER'S RECOMMENDATIONS

INLAYS

Inscription™ Black Walnut Wood trim

EXTERIOR COLOURS

- 019 Black Stone
- 452 Black Sapphire metallic
- 455 Titanium Grey pearl
- 473 Shimmer Gold pearl
- 477 Inscription™ Electric Silver Coarse Flake metallic
- 487 Inscription™ Ember Black pearl
- 492 Savile Grey pearl



CH7H

UPHOLSTERY AND INTERIOR COLOURS
Noble Blue/Off Black Inscription™ Soft Leather with Noble Blue stitching. Off Black interior with Granite headliner and Off Black Luxury Floor Mats with Noble Blue piping.

DESIGNER'S RECOMMENDATIONS

INLAYS

Inscription™ Black Walnut Wood trim

EXTERIOR COLOURS

- 019 Black Stone
- 452 Black Sapphire metallic
- 455 Titanium Grey pearl
- 473 Shimmer Gold pearl
- 477 Inscription™ Electric Silver Coarse Flake metallic
- 480 Shadow Blue pearl
- 487 Inscription™ Ember Black pearl
- 492 Savile Grey pearl



CH7D

UPHOLSTERY AND INTERIOR COLOURS
Serene Sand/Off Black Inscription™ Soft Leather with Serene Sand stitching. Off Black interior with Granite headliner and Off Black Luxury Floor Mats with Serene Sand piping.

DESIGNER'S RECOMMENDATIONS

INLAYS

Inscription™ Black Walnut Wood trim

EXTERIOR COLOURS

- 019 Black Stone
- 426 Silver metallic
- 452 Black Sapphire metallic
- 455 Titanium Grey pearl
- 473 Shimmer Gold pearl
- 477 Inscription™ Electric Silver Coarse Flake metallic
- 480 Shadow Blue pearl
- 487 Inscription™ Ember Black pearl
- 492 Savile Grey pearl
- 493 Capar Green pearl



CH2V

UPHOLSTERY AND INTERIOR COLOURS
Espresso Inscription™ Soft Leather with Espresso stitching. Sandstone beige interior with Arena headliner and Sandstone beige Luxury Floor Mats with Espresso piping.

DESIGNER'S RECOMMENDATIONS

INLAYS

Inscription™ Black Walnut Wood trim

EXTERIOR COLOURS

- 426 Silver metallic
- 452 Black Sapphire metallic
- 473 Shimmer Gold pearl
- 477 Inscription™ Electric Silver Coarse Flake metallic
- 487 Inscription™ Ember Black pearl
- 493 Capar Green pearl



CH2L

UPHOLSTERY AND INTERIOR COLOURS

Linen White Inscription™ Soft Leather with Linen White Stitching. Sandstone beige interior with Arena headliner and Sandstone beige Luxury Floor Mats with Linen White piping.

DESIGNER'S RECOMMENDATIONS

INLAYS

Inscription™ Black Walnut Wood trim

EXTERIOR COLOURS

- 019 Black Stone
- 454 Ruby Red pearl
- 473 Shimmer Gold pearl
- 477 Inscription™ Electric Silver Coarse Flake metallic
- 480 Shadow Blue pearl
- 487 Inscription™ Ember Black pearl
- 493 Capar Green pearl
- 614 Ice White



CH7J

UPHOLSTERY AND INTERIOR COLOURS

Toscana Tan Inscription™ Soft Leather with Toscana Tan stitching. Off Black interior with Granite headliner and Off Black Luxury Floor Mats with Toscana Tan piping.

DESIGNER'S RECOMMENDATIONS

INLAYS

Inscription™ Black Walnut Wood trim

Cross Brushed Aluminium trim

EXTERIOR COLOURS

- 019 Black Stone
- 426 Silver metallic
- 452 Black Sapphire metallic
- 455 Titanium Grey pearl
- 477 Inscription™ Electric Silver Coarse Flake metallic
- 480 Shadow Blue pearl
- 487 Inscription™ Ember Black pearl
- 492 Savile Grey pearl



CH7G

UPHOLSTERY AND INTERIOR COLOURS

Off Black Inscription™ Soft Leather with Off Black stitching. Off Black interior with Granite headliner and Off Black Luxury Floor Mats with Off Black piping.

DESIGNER'S RECOMMENDATIONS

INLAYS

Inscription™ Black Walnut Wood trim

Cross Brushed Aluminium trim

EXTERIOR COLOURS

- 019 Black Stone
- 426 Silver metallic
- 452 Black Sapphire metallic
- 454 Ruby Red pearl
- 455 Titanium Grey pearl
- 477 Inscription™ Electric Silver Coarse Flake metallic
- 480 Shadow Blue pearl
- 487 Inscription™ Ember Black pearl
- 492 Savile Grey pearl
- 493 Capar Green pearl



CH7L

UPHOLSTERY AND INTERIOR COLOURS

Linen White Inscription™ Soft Leather with Linen White stitching. Off Black interior with Granite headliner and Off Black Luxury Floor Mats with Linen White piping.

DESIGNER'S RECOMMENDATIONS

INLAYS

Inscription™ Black Walnut Wood trim

EXTERIOR COLOURS

- 019 Black Stone
- 453 White pearl
- 454 Ruby Red pearl
- 473 Shimmer Gold pearl
- 477 Inscription™ Electric Silver Coarse Flake metallic
- 480 Shadow Blue pearl
- 487 Inscription™ Ember Black pearl
- 493 Capar Green pearl
- 614 Ice White



Inscription™ Luxury Floor Mats with Nubuck Piping



Inscription™ Sports steering wheel

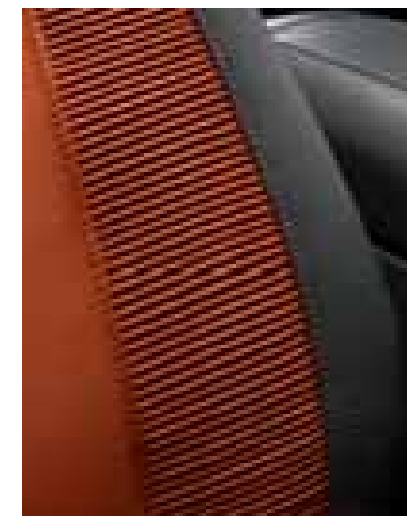

Ribbed Upholstery Inserts



Sapeli Wood



Black Walnut Wood (Inscription™ Only)



Dark Wood

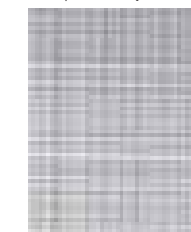

Cross Brushed Aluminium



In fine detail

The nuts and bolts of your Volvo XC90. Whatever you need to know about your new car – whether that's fuel consumption, CO₂ emissions, top speed or boot space – you'll find it here.

ENGINE	3.2 Geartronic	V8 Geartronic	D5
Configuration	Transverse – 24 valve	Transverse – 32 valve	Transverse – 20 valve
Cylinders	6	8	5
Engine capacity, cc	3192	4414	2400
Bore x stroke, mm	84 x 96	94 x 79.5	81 x 93.1
Max. output ECE, PS/kw/rpm	238/175/6200	315/232/5850	185/136/4000
Max. torque ECE, Nm/rpm	320/3200	440/3900	400/2000-2750
Octane rating	95-98 RON unleaded ⁽ⁱ⁾	95-98 RON unleaded ⁽ⁱ⁾	Turbo Diesel
Fuel system	Port fuel injection	Port fuel injection	Common rail direct injection
Compression ratio	10.8:1	10.4:1	17.3:1

PERFORMANCE	3.2 Geartronic	V8 Geartronic	Manual	D5 Geartronic
Top speed, mph	130	130	121	118
Acceleration 0-60 mph, sec	8.9	6.9	10.3	11.1
0-62 mph (0-100 kmh), sec	9.5	7.3	10.9	11.5
Drag co-efficient	0.36	0.36		0.36

FUEL CONSUMPTION ⁽ⁱⁱ⁾⁽ⁱⁱⁱ⁾	3.2 Geartronic	V8 Geartronic	Manual	D5 Geartronic
(Government Approved) Mpg (l/100 km)				
Urban	16.4 (17.2)	14.1 (20.0)	26.4 (10.7)	25.4 (11.1)
Extra Urban	30.7 (9.2)	28.8 (9.8)	40.9 (6.9)	40.4 (7.0)
Combined	23.3 (12.1)	20.9 (13.5)	34.0 (8.3)	33.2 (8.5)
CO ₂ g/km	289	322	219	224
VED (Vehicle Excise Duty) Band	G	G	F	F
Emission Standard	Euro IV	Euro IV		Euro IV

POWER STEERING SYSTEM	All models	
(rack & pinion)	235 Tyres	12.5 (41.0)
Turning circle, m (ft)	255 Tyres	13.1 (43.0)

	3.2	V8	D5
Brakes			
	Disc Diameter Front, mm	17" – 336 Ventilated 308	17" – 336 Ventilated 308
Transmission			
	Manual Geartronic	– 6 speed	– 6 speed
Fuel Tank Volume			
	litres (gallons)	80 (17.6)	80 (17.6)

LUGGAGE COMPARTMENT	
Volume, 2nd/3rd Row Folded, litres (cu.ft)	1837 (64.9)
Volume, 2nd Row Up/3rd Row Folded, litres (cu.ft)	615 (21.7)
Volume, 2nd/3rd Row Up, litres (cu.ft)	249 (8.8)

INSURANCE GROUPS	3.2 Geartronic	V8 Geartronic	D5
S	–	–	15E
SE	16E	19E	15E
SE Lux	16E	19E	15E
Executive	16E	19E	17E
	16E	19E	15E

E = Exceeds security requirements for model concerned and group rating has been reduced.

WEIGHTS	3.2 Geartronic	V8 Geartronic	Manual	D5 Geartronic
Min. kerb weight, kg (actual kerb weight dependent on spec)	2147	2193	2119	2135
Max. possible towing weight braked, kg	2250	2250	2250	2250
Max. towing weight unbraked approx, kg ^(iv)	750	750	750	750
Max towball weight, kg	90	90	90	90
Max. total weight, kg	2760	2770	2740	2750
Max. roof load, kg	100	100	100	100
Max. payload, kg (dependent on spec)	613	577	621	615

GROUND CLEARANCE	
Vehicle Ground Clearance, mm	218
With 2 persons, mm	207
Wading Depth, mm	400
Approach Angle	28°
Departure Angle	25°
Breakover Angle	20°

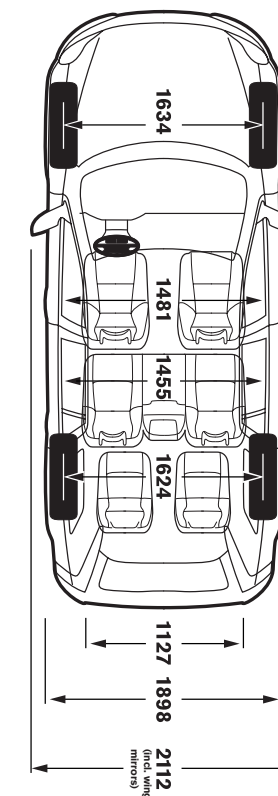
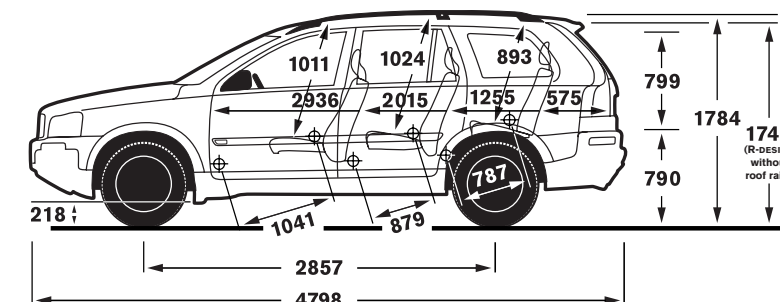

Notes

- (i) For best performance and lowest fuel consumption 98 RON is recommended. 95 RON can be used for normal driving.
- (ii) These results do not express or imply any guarantee of the fuel consumption of a particular car as there are inevitable differences between individual cars of the same model. Additionally driving style, traffic conditions, as well as the age, mileage and standard of maintenance will affect a car's fuel consumption.
- (iii) The Urban fuel consumption figure is based on typical city driving, including starting the car from cold. The Extra Urban figure is based on typical motorway driving and cruising. The Combined figure averages the consumption across both cycles.
- (iv) Unbraked towing weight must not exceed 50% of kerb weight up to a maximum of 750 kg.

The weight of the vehicle will influence the level of CO₂ emitted. As a result, vehicles with higher levels of specification and factory fit options may emit higher levels of CO₂. Once a vehicle has been built it will be given its own specific CO₂ emission on which the Vehicle Excise Duty will be charged. A weighbridge must be used to determine specific weights. Data valid for manual transmission unless specified. All measurements in mm. The Max. output figures are quoted in PS (Pferdestärke), which is the metric equivalent of brake horsepower. NB Some of the information in this price list may not be correct due to product changes which may have occurred since it was printed. Some of the equipment described or shown may now be available only at extra cost. Before ordering, please ask your Volvo dealer for the latest information. The manufacturer reserves the right to make changes at any time, without notice, to prices, colour, materials, specifications and models. Volvo Car UK Limited, Globe Park, Marlow, Buckinghamshire, SL7 1YQ.

Accessories from Volvo

Of course, your Volvo XC90 won't be perfect until it's exactly how you want it. And that's why we offer a range of accessories so you can completely personalise your new car. **The prices quoted below exclude fitting costs and are correct at time of going to press** – please confirm the total cost with your local Volvo dealer.

ACCESSORIES	Basic £	VAT £	Rec Retail Price £
EXTERIOR ACCESSORIES			
Aluminum Bike Rack (down tube clamp)	£53.13	£9.30	£62.43
Bike Rack (servo lift)	£84.12	£14.72	£98.84
Bike Rack (cargo area)	£53.13	£9.30	£62.43
Bike Rack (towbar mounted and collapsible)	£293.46	£51.35	£344.81
Bike Carrier – extra bicycle towbar mounted	£69.20	£12.11	£81.31
Load Carrier – wing profile	£83.29	£14.58	£97.87
Sport Styling Kit	£520.00	£91.00	£611.00
Mud Flaps Front, Mud Flaps Rear (price per pair)	£20.97	£3.67	£24.64
Roofbox – Sport Time 200 (440 litre volume) ⁽ⁱ⁾	£153.56	£26.87	£180.43
Roof Protection Ribs	£89.83	£15.72	£105.55
Running Boards with Anti-slip Footplate	£362.86	£63.50	£426.36
Ski/Snowboard Carrier with Sliding Rail	£58.87	£10.30	£69.18
Snow Chain – standard version (variety available) ...from	£125.76	£22.01	£147.77
Towbar – Detachable type with 13 Pin Electrics ⁽ⁱⁱ⁾	£325.64	£56.99	£382.63
Park Assist Camera (RTI required)	£426.01	£74.55	£500.56
Front Park Assist	£165.98	£29.05	£195.03
INTERIOR ACCESSORIES			
Garmin Portable Sat Nav	£310.64	£54.36	£365.00
Boot Mat – textile/rubber reversible for 7 seats	£88.58	£15.50	£104.08
Boot Mat – moulded plastic 7 seats	£88.58	£15.50	£104.08
Boot Mat – moulded plastic 5 seats	£75.27	£13.17	£88.44
Bluetooth* ...from	£173.67	£30.39	£204.06
Load Liner – full cargo area	£57.56	£10.07	£67.63
Load Securing Straps (cargo area)	£28.79	£5.04	£33.83
Net Pocket (cargo area)	£20.90	£3.66	£24.56
RSE – Rear Seat Entertainment Roof Mounted Single Screen	£693.26	£121.32	£814.58
RSE – Rear Seat Entertainment – 2 x 6" Screens in Headrest	£1,127.74	£197.35	£1,325.09
iPod Interface	£238.30	£41.70	£280.00
USB Interface	£238.30	£41.70	£280.00
Combined USB/iPod Interface	£238.30	£41.70	£280.00
Rubber Floor Mats (set of four)	£46.04	£8.06	£54.10
Rubber Floor Mats (third row)	£27.65	£4.84	£32.49
Steel Safety Grille	£148.60	£26.01	£174.61
Sunblind – rear door windows (pair)	£26.31	£4.60	£30.91
Sunblind – rear compartment (3 pieces)	£25.80	£4.51	£30.31
CHILD			
Child Seat ISOFIX ⁽ⁱⁱⁱ⁾	£127.40	£6.37	£133.77
Infant Seat ISOFIX ⁽ⁱⁱⁱ⁾	£89.92	£4.50	£94.42
ISOFIX base	£94.63	£16.56	£111.18
Baby Insert	£28.27	£4.95	£33.22
Child Booster Cushion	£30.69	£5.37	£36.06
Child Booster Backrest (to go with above)	£30.69	£5.37	£36.06

⁽ⁱ⁾ Other roofboxes available – please ask your dealer for details. ⁽ⁱⁱ⁾ Detachable 7 pin and Fixed 13 and 7 pin also available – please ask your dealer for details. ⁽ⁱⁱⁱ⁾ VAT on Child Seats is 5%.

For further information and a complete list of all Volvo Accessories, take a look at the Accessory website at www.volvocars.co.uk/accessories or visit your local dealer.

Try an XC90 for yourself with Volvo Rental

Why not hire a Volvo XC90 – or any other Volvo – from Volvo Rental? You'll be guaranteed to drive a Volvo prepared to the highest standards by your local Volvo dealer. Call 0800 400 430 for more information today.



The end is just the beginning

It's a simple idea; one point of contact for all your car ownership needs – whether it's about finding the right finance deal or who to contact in an emergency. To get the most out of owning your Volvo, trust Care by Volvo.

MAKING LIFE EASIER

Owning a Volvo should be a safe and enjoyable experience. To ensure it stays that way, we're committed to providing you with the best in support for as long as you own one.

STARTING OFF ON THE RIGHT FOOT

You might be surprised how easy and flexible financing can be. Our range of finance, service and insurance options allows you to budget around one key factor – your lifestyle.

FINANCE

As part of Volvo, Volvo Car Finance has developed a series of funding plans that will provide you with maximum choice and flexibility when acquiring a Volvo®. For details of the current promotions available, please visit www.volvocars.co.uk/financepromotions

INSURANCE

Volvo Owners Insurance is designed for Volvo drivers and because we know Volvos inside out, we can offer exactly the right tools and expertise, fitting only genuine Volvo parts by trained Volvo technicians⁽ⁱⁱ⁾. Because Volvo drivers have an excellent reputation, we can also offer extensive cover at a reasonable price⁽ⁱⁱⁱ⁾.

Call now for your insurance quote on **0800 238 239**, quoting reference BROCH.



WHAT NEXT? If you'd like to find out more about the range of products and services that make up Care by Volvo, the story continues at www.volvocars.co.uk. Alternatively you can contact your nearest Volvo dealer or request relevant brochures.

⁽ⁱ⁾ Finance subject to status. Guarantees/indemnities may be required. Volvo Car Finance SL7 1YQ.

⁽ⁱⁱ⁾ When using a Volvo approved repairer.

⁽ⁱⁱⁱ⁾ Volvo Owners Insurance is underwritten by Royal & Sun Alliance Insurance plc (No. 93792). Registered in England and Wales at St Mark's Court, Chart Way, Horsham, West Sussex RH12 1XL. Authorised and regulated by the Financial Services Authority. For your protection telephone calls will be recorded and may be monitored. All benefits are subject to qualifying status, terms and conditions, cover level and underwriting criteria. Service and repair benefits are subject to being carried out by a recommended repairer.

SERVICE PROGRAMME

Your Volvo dealer has the unique know-how to tailor a service programme according to Volvo's strict recommendations and guarantees you years of safety and driving pleasure.

VOLVO ON CALL

Subscribe to Volvo On Call and you'll never be completely on your own. It's a GPS-based communication system providing 24-hour access to both emergency and roadside assistance wherever you are. See the Volvo On Call brochure for more information.

LOOKING AHEAD

You'll probably never find out just how good some of these services are. But should the unexpected happen, we'd like to think that you'd be even happier you chose a Volvo.

ROADSIDE ASSISTANCE

Every new car comes with one year's Volvo Assistance cover. You'll enjoy free breakdown and recovery assistance, anywhere in Europe, 24 hours a day. You can even extend cover for £85 for one year or £155 for two years. Call Volvo Assistance on **08701 650 978**.

WARRANTY

Every new Volvo comes with comprehensive protection. Our warranty covers the first three years or 60,000 miles, whichever comes first. There's a three year unlimited mileage warranty on the paintwork, and either eight or twelve years against rust perforation. If a component fails due to a defect or material fault, your dealer will swiftly rectify the problem, free of charge.

Volvo. for life

For tax free sales, including Military, Diplomat and all other Export enquiries, contact Volvo Car UK Tourist & Diplomat Sales or Volvo Car UK British Military Sales on **01707 262 388** or e-mail to vcukics@volvocars.com or bms@volvocars.com

All 'On The Road' prices quoted in this price list include Volvo standard national delivery charge, inclusive of number plates at £530 and the VED (Vehicle Excise Duty) car tax as of 1st September 2008. The 'On The Road' price also includes a £55 vehicle first registration fee (as set by the government – excludes Channel Islands and Isle of Man). Retail prices quoted do not include these additions.

NB Some of the information in this price list may not be correct due to product changes which may have occurred since it was printed. Before ordering, please ask your Volvo dealer for the latest information. The manufacturer reserves the right to make changes at any time, without notice, to prices, colour, materials, specifications and models.