

# VOLVO V70

PRICE AND SPECIFICATION



## Create your perfect Volvo V70

Congratulations. You're only a few steps away from your perfect Volvo V70. This price list contains everything you need to create the car that's exactly right for you.

From selecting the right package and choosing from a range of class leading engines, through to picking the perfect colour and adding the finishing touches, you're in complete control. You'll also find full engine details and in-depth technical specifications to help you make the most informed choice.

Whatever you decide, you'll be choosing Volvo's 10th generation of estate car. The Volvo V70 boasts more luxury, more onboard intelligence, more practical space and more of what we're known for and proudest of – safety.





## V70 SE

The SE aims to spoil. Its luxurious interior boasts supportive seats with Sundby Textile/T-Tec upholstery – electronically adjustable for the driver. Then there's the 8 speaker High Performance audio system with 160 W output and intuitive features such as automatic rain sensor and autodimming rear view mirror with compass. On the outside, 17" Spartes alloy wheels and colour co-ordinated front spoiler and side mouldings make sure your presence doesn't go unnoticed.

## V70 SE LUX

The SE Lux model is the ultimate word in luxury. Leather-faced upholstery, modern wood trim, heated and powered front seats and luxury floor mats further enhance the luxurious interior. 17" Canicula alloy wheels, Active Bending headlamps, chrome window trim, power tailgate, silver roof rails and rear park assist offer both style and protection.

## V70 *R*DESIGN

The R-DESIGN model combines the luxury features of the SE, with sports styling and handling enhancements. Speed dependent power steering with unique 18" Cratus alloy wheels and R-DESIGN chassis enhance the handling. Visual presence is further enhanced with silver matt door mirrors, unique rear exhaust pipes, together with R-DESIGN leather-faced upholstery, front sports seats with side support, R-DESIGN leather steering wheel and unique aluminium interior trim.

## V70 SE

	Basic £	VAT £	Rec Retail Price £	On the Road Price £
<b>PETROL</b>				
2.0 (145 PS) SE	£20,638.30	£3,611.70	£24,250.00	£24,995.00
2.5T (200 PS) SE	£21,914.89	£3,835.11	£25,750.00	£26,685.00
3.2 (238 PS) SE Geartronic	£25,319.15	£4,430.85	£29,750.00	£30,685.00
T6 AWD (285 PS) SE Geartronic	£29,404.26	£5,145.74	£34,550.00	£35,485.00
<b>DIESEL</b>				
2.0D (136 PS) SE	£21,119.15	£3,695.85	£24,815.00	£25,495.00
2.4D (163 PS) SE	£22,395.74	£3,919.26	£26,315.00	£27,020.00
D5 (185 PS) SE	£23,246.81	£4,068.19	£27,315.00	£28,020.00
D5 AWD (185 PS) SE	£24,268.09	£4,246.91	£28,515.00	£29,260.00
<b>FLEXIFUEL</b>				
2.0F (145 PS) SE	£20,893.62	£3,656.38	£24,550.00	£25,295.00
2.5FT (200 PS) SE	£22,170.21	£3,879.79	£26,050.00	£26,795.00

## V70 SE LUX

	Basic £	VAT £	Rec Retail Price £	On the Road Price £
<b>PETROL</b>				
2.5T (200 PS) SE Lux	£24,510.64	£4,289.36	£28,800.00	£29,735.00
3.2 (238 PS) SE Lux Geartronic	£27,914.89	£4,885.11	£32,800.00	£33,735.00
T6 AWD (285 PS) SE Lux Geartronic	£31,982.98	£5,597.02	£37,580.00	£38,515.00
<b>DIESEL</b>				
2.0D (136 PS) SE Lux	£23,714.89	£4,150.11	£27,865.00	£28,545.00
2.4D (163 PS) SE Lux	£24,991.49	£4,373.51	£29,365.00	£30,070.00
D5 (185 PS) SE Lux	£25,842.55	£4,522.45	£30,365.00	£31,070.00
D5 AWD (185 PS) SE Lux	£26,863.83	£4,701.17	£31,565.00	£32,310.00
<b>FLEXIFUEL</b>				
2.5FT (200 PS) SE Lux	£24,765.96	£4,334.04	£29,100.00	£29,845.00

## V70 *R*DESIGN

	Basic £	VAT £	Rec Retail Price £	On the Road Price £
<b>PETROL</b>				
2.0 (145 PS) R-DESIGN	£22,127.66	£3,872.34	£26,000.00	£26,745.00
2.5T (200 PS) R-DESIGN	£23,404.26	£4,095.74	£27,500.00	£28,435.00
3.2 (238 PS) R-DESIGN Geartronic	£26,808.51	£4,691.49	£31,500.00	£32,435.00
T6 AWD (285 PS) R-DESIGN Geartronic	£30,893.62	£5,406.38	£36,300.00	£37,235.00
<b>DIESEL</b>				
2.0D (136 PS) R-DESIGN	£22,608.51	£3,956.49	£26,565.00	£27,245.00
2.4D (163 PS) R-DESIGN	£23,885.11	£4,179.89	£28,065.00	£28,770.00
D5 (185 PS) R-DESIGN	£24,736.17	£4,328.83	£29,065.00	£29,770.00
D5 AWD (185 PS) R-DESIGN	£25,757.45	£4,507.55	£30,265.00	£31,010.00
<b>FLEXIFUEL</b>				
2.0F (145 PS) R-DESIGN	£22,382.98	£3,917.02	£26,300.00	£27,045.00

## On the road

How much will it cost to get behind the wheel of your own Volvo V70? Simply decide which model variant and engine type are right for you and then take a look at the full price list opposite.



# The right equipment

It's essential that your Volvo comes equipped with everything you need. Below you'll find the standard equipment lists for each model variant, plus optional equipment to personalise your Volvo V70. And as you'd expect, there is an array of industry-leading, cutting edge safety innovations.

STANDARD EQUIPMENT - SAFETY & SECURITY	SE	SE LUX	RDESIGN
Dual Stage Driver and Passenger Airbags	•	•	•
SIPS (Side Impact Protection System)	•	•	•
Dual Chamber SIPS Airbags	•	•	•
IC (Inflatable Curtain)	•	•	•
WHIPS (Whiplash Protection System)	•	•	•
ABS (Anti-lock Brake System) and FBS (Fading Brake Support) with HBA (Hydraulic Brake Assist), OHB (Optimised Hydraulic Brakes), EBD (Electronic Brake Distribution), RAB (Ready Alert Brakes) and EBL (Emergency Brake Lights)	•	•	•
DSTC (Dynamic Stability and Traction Control)	•	•	•
5 Three Point Seat Belts	•	•	•
Seat Belt Pre-tensioners (Front and Rear)	•	•	•
Head Restraints - All 5 Seats	•	•	•
ISOFIX Attachment (Rear Seats)	•	•	•
Anti-theft Alarm including Immobiliser, Volume Sensor and Level Sensor	•	•	•
Key Integrated Remote Control Central Locking including Fuel Flap with Deadlocking System and Global Opening/Closing of Windows/Sunroof	•	•	•
Tinted Windscreen	•	•	•
Load Cover (Cargo Area) with Nylon Load Protection Net	•	•	•
3D Cargo Load System (Aluminium Cargofix Rails with 4 Attachments and 4 Aluminium High Level Anchor Points)	•	•	•
Lockable Load Floor	•	•	•
Visible VIN Plate	•	•	•
Day Running Lights	•	•	•
Headlamp Levelling System	•	•	•
Adaptive Brake Lights including High Level LED Brake Light	•	•	•
Power Parking Brake	•	•	•
Side Marker Illumination	•	•	•
Home Safe and Approach Lighting	•	•	•
IDIS (Intelligent Driver Information System)	•	•	•
Warning Triangle	•	•	•

STANDARD EQUIPMENT - EXTERIOR	SE	SE LUX	RDESIGN
17" Spartes Alloy Wheels (Silver Stone) - 225/50 R17 W Tyres	•	•	•
17" Canicula Alloy Wheels (Silver Bright) - 225/50 R17 W Tyres			•
18" Cratus Alloy Wheels (Silver Bright) - 245/40 R18 Y Tyres			•
Locking Wheel Nuts	•	•	•
Tyre Sealant Kit	•	•	•
Active Bending Headlamps with Headlamp Cleaning System		•	•
Autofolding Power Door Mirrors with Ground Lights	•	•	•
Power Adjustable and Heated Door Mirrors	•	•	•
Front Fog Lights	•	•	•
Heated Washer Nozzles		•	•
Power Tailgate		•	•
Rear Spoiler			•
RDESIGN Grille with Logo			•
Rain Sensor - Automatic Windscreen Wiper Activation	•	•	•
RDESIGN Lowered Sports Chassis			•
Roof Rails (Silver - SE Lux and RDESIGN)	•	•	•
Chrome Window Trim		•	•
Volvo Treadplates (Front)	•	•	•
Colour Co-ordinated Bumpers and Door Mirrors	•	•	•
RDESIGN Silver Matt Door Mirrors			•
Colour Co-ordinated Lower Door and Bumper Mouldings	•	•	•
Twin Aluminium Exhaust End Pipes (T6 AWD only)	•	•	•
Rear Park Assist		•	•
Electronic All Wheel Drive System with Instant Traction™ (Haldex Coupling) (T6 AWD and D5 only)	•	•	•

STANDARD EQUIPMENT - INTERIOR	SE	SE LUX	RDESIGN
ECC (Electronic Climate Control) with AQS (Air Quality System) and Pollen Filter	•	•	•
B Pillar Ventilation	•	•	•
Information Centre	•	•	•
Cruise Control	•	•	•
Speed Dependent Steering System with 3 Settings (Standard RDESIGN and T6 AWD only)	•	•	•
Front and Rear Power Windows	•	•	•
Illuminated Driver and Passenger Vanity Mirrors	•	•	•
Front and Rear Reading Lights	•	•	•
Autodimming Rear View Mirror with Compass	•	•	•
Grocery Bag Holder	•	•	•
12V Socket (Front and Rear Tunnel Console/Cargo Area)	•	•	•
Power Driver's Seat with Seat Memory	•	•	•
Power Passenger Seat		•	•
Height Adjustable Driver and Passenger Seats with Lumbar Support	•	•	•
Forward Folding Front Passenger Seat	•	•	•
Versatile Split-folding Rear Seat (40%/20%/40%)	•	•	•
Heated Front Seats		•	•
Leather Steering Wheel and Gear Knob	•	•	•
RDESIGN Leather Sports Steering Wheel with Logo			•
RDESIGN Sports Gear Knob			•
Steering Wheel Remote Audio Controls	•	•	•
Chronograph Instrument Dials (T6 AWD only)	•	•	•
RDESIGN Unique Instrument Dials			•
Chrome Rotary Knobs	•	•	•
Chrome Trim on Air Vents, Side Defrosters and Mannequin		•	•
Height and Reach Adjustable Steering Column	•	•	•
Cross Brushed Aluminium Trim	•		•
Modern Wood Trim		•	•
RDESIGN Aluminium Trim			•
Sundby Textile/T-Tec Upholstery	•		•
Leather-faced Upholstery		•	•
RDESIGN Leather-faced Sports Upholstery with Logo			•
Luxury Floor Mats		•	•
RDESIGN Sports Floor Mats			•
RDESIGN Aluminium Sports Pedals			•
High Performance Sound Audio System - 1 x CD/Radio, 4 x 40W Amplifier, Aux Input (MP3/WMA Compatible) and 8 Speakers	•	•	•



OPTIONAL EQUIPMENT – SAFETY & SECURITY	Basic £	VAT £	Rec Retail Price £	SE	SE LUX	R-DESIGN
BLIS (Blind Spot Information System)	£382.98	£67.02	£450.00	o	o	o
Passenger Airbag Cut Off Switch	£21.28	£3.72	£25.00	o	o	o
PCC (Personal Car Communicator) with Heartbeat Sensor and Keyless Drive	£425.53	£74.47	£500.00	o	o	o
ACC (Adaptive Cruise Control) with Distance Alert and Collision Warning with Auto Brake (not 2.0, 2.0D, 2.0F, 2.5FT and 2.5T)(i)	£1,106.38	£193.62	£1,300.00	o	o	o
LDW (Lane Departure Warning) with DAC (Driver Alert Control)(i)	£425.53	£74.47	£500.00	o	o	o
Dark Tinted Windows (Rear Side Doors and Cargo Area)	£212.77	£37.23	£250.00	o	o	o
Private Locking	£21.28	£3.72	£25.00	o	o	o
360° Laminated Windows including Cargo Area (Front Side Windows are Water Repellent)	£382.98	£67.02	£450.00	o	o	o
IR (Infrared) Reflective Glass Windscreen	£127.66	£22.34	£150.00	o	o	o
Power Child Locks (Rear Doors)	£63.83	£11.17	£75.00	o	o	o
Homelink	£42.55	£7.45	£50.00	o	o	o
First Aid Kit	£21.28	£3.72	£25.00	o	o	o

OPTIONAL EQUIPMENT – EXTERIOR	Basic £	VAT £	Rec Retail Price £	SE	SE LUX	R-DESIGN
Black Paint (Solid)	£212.77	£37.23	£250.00	o	o	o
Metallic/Pearlescent Paint	£510.64	£89.36	£600.00	o	o	o
Inscription™ Paint	£659.57	£115.43	£775.00	o	o	o
17" Spartes Alloy Wheels (Silver Stone) – 225/50 R17 W Tyres	-	-	-	●	nco	n/a
17" Regor Alloy Wheels (Silver Bright) – 225/50 R17 W Tyres	-	-	-	nco	nco	n/a
17" Cassini Alloy Wheels (Silver Bright) – 225/50 R17 W Tyres	-	-	-	nco	nco	n/a
18" Odysseus Alloy Wheels (Silver Bright) – 245/40 R18 Y Tyres	£553.19	£96.81	£650.00	o	o	n/a
18" Venator Alloy Wheels (Silver Bright) – 245/40 R18 Y Tyres	£553.19	£96.81	£650.00	o	o	n/a
18" Zubra Alloy Wheels (Silver Bright) – 245/40 R18 Y Tyres	£553.19	£96.81	£650.00	o	o	n/a
18" Fortuna Alloy Wheels (Diamond Cut/Graphite) – 245/40 R18 Y Tyres	£595.74	£104.26	£700.00	o	o	u (£50)
18" Venator Alloy Wheels (Chromed) – 245/40 R18 Y Tyres	£1,310.64	£229.36	£1,540.00	o	o	n/a
TPMS (Tyre Pressure Monitoring System)	£170.21	£29.79	£200.00	o	o	o
SST (Self Supporting Tyres) (Not D5 and AWD Models)(ii)	£170.21	£29.79	£200.00	o	o	n/a
Tempa Spare Wheel	-	-	-	nco	nco	nco
Power Tailgate	£297.87	£52.13	£350.00	o	●	o
Delete Roof Rails	-	-	-	nco	nco	nco
Rear Park Assist	£297.87	£52.13	£350.00	o	●	o
Front and Rear Park Assist	£553.19	£96.81	£650.00	o	u (£300)	o
Load Compensating Suspension	£425.53	£74.47	£500.00	o	o	n/a
Active Four-C Chassis (Continuously Controlled Chassis Concept)(iii)	£936.17	£163.83	£1,100.00	o	o	n/a

● = Standard, o = optional, n/a = not available, nco = no cost option, u (£) = upgrade, ® = Registered Trademark.

(i) Cannot be ordered in conjunction with IR (Infrared) Reflective Glass Windscreen.

(ii) Must be ordered in conjunction with 17" Canicula or 17" Spartes Alloy Wheels and TPMS (Tyre Pressure Monitoring System).

(iii) Four-C Chassis cannot be combined with Load Compensating Suspension.

(iv) Heated Rear Seats must be combined with Heated Front Seats on SE and R-DESIGN and cannot be combined with Integrated 2-stage Booster Cushions x2.

(v) Can only be combined with E112, E212, E412, E514 and E812 Upholsteries and is not available in combination with Walnut Wood Steering Wheel.

(vi) Must be ordered in conjunction with Walnut Wood Trim.

(vii) Cannot be ordered in conjunction with Modern Wood Trim or Dark Finesline Trim.

(viii) Must be ordered in conjunction with Power Driver/Passenger Seats (SE models).

(ix) Dolby and Pro Logic Surround Sound™ are trademarks of Dolby Laboratories Licensing Corporation.

(x) Must be ordered in conjunction with Rear Seat Entertainment.

(xi) Volvo On Call includes Safety package (Security package available at additional cost). Must be ordered in conjunction with RTI Navigation System with RDS-TMC, Remote Control with Europe DVD Maps.

(xii) Cannot be ordered in conjunction with Dual Band Integrated GSM Telephone and Volvo On Call.

(xiii) Must be ordered in conjunction with accessory Rubber Floor Mats and Luggage Compartment Mat. CZIP cannot be combined with Luxury Floor Mats, Winter Pack with Active Bending Headlamps and front and rear Ashtray with Cigarette Lighter.



OPTIONAL EQUIPMENT – INTERIOR	Basic £	VAT £	Rec Retail Price £	SE	SE LUX	R-DESIGN
Geartronic Transmission (Standard 3.2 and T6 AWD only) (not 2.0, 2.0D, 2.0F and 2.5FT) and T6 AWD only)	£1,191.49	£208.51	£1,400.00	o	o	o
Speed Dependent Steering System with 3 Settings (Standard R-DESIGN)	£191.49	£33.51	£225.00	o	o	●
Power Glass Tilt and Slide Sunroof	£723.40	£126.60	£850.00	o	o	o
Rear Centre Armrest with Cupholders and Storage	£29.79	£5.21	£35.00	o	o	o
Front and Rear Ashtray with Cigarette Lighter	-	-	-	nco	nco	nco
Power Driver and Passenger Seats with Driver's Seat Memory	£510.64	£89.36	£600.00	o	●	o
Heated Front Seats	£191.49	£33.51	£225.00	o	●	o
Heated Rear Seats(iv)	£191.49	£33.51	£225.00	o	o	o
Anthracite Black Dash Top, Steering Wheel, Steering Column and Gear Knob(v)	-	-	-	nco	nco	n/a
Walnut Wood Gear Knob (Geartronic Only)(vi)	£34.04	£5.96	£40.00	o	o	n/a
Cross Brushed Aluminium Trim	-	-	-	●	nco	n/a
Dark Finesline Trim	-	-	-	nco	nco	n/a
Modern Wood Trim	£212.77	£37.23	£250.00	o	●	n/a
Walnut Wood Trim	£212.77	£37.23	£250.00	o	nco	n/a
Walnut Wood Steering Wheel(vi)(vii)	£204.26	£35.74	£240.00	o	o	n/a
Vitige Leather/Textile Upholstery	£553.19	£96.81	£650.00	o	n/a	n/a
Leather-faced Upholstery	£765.96	£134.04	£900.00	o	●	n/a
Ventilated Leather-faced Upholstery(viii)	£1,276.60	£223.40	£1,500.00	o	u (£300)	n/a
Sovereign Hide Upholstery	£2,212.77	£387.23	£2,600.00	o	u (£1,400)	n/a
6 x CD Player (MP3/WMA Compatible)	£212.77	£37.23	£250.00	o	o	o
Dynaudio Premium Sound Audio System – 1 x CD/Radio with Dolby Pro Logic II Surround Sound(ix), 5 x 130W Amplifier, Aux Input (MP3/WMA Compatible) and 12 Dynaudio Speakers	£851.06	£148.94	£1,000.00	o	o	o
Subwoofer (2 x 6.5" Subwoofer with 2 x 130W Amplifier)	£153.19	£26.81	£180.00	o	o	o
Rear Seat Entertainment with 1 x DVD Player in Front Centre Armrest, 2 x 8" screens, 2 x IR Headphones and Remote Control	£1,148.94	£201.06	£1,350.00	o	o	o
Rear Seat Audio Console with Headphone Sockets x 2	£80.85	£14.15	£95.00	o	o	o
Digital TV(x)	£340.43	£59.57	£400.00	o	o	o
RTI Navigation System with RDS-TMC, Remote Control with Europe DVD Maps	£1,574.47	£275.53	£1,850.00	o	o	o
Bluetooth® Handsfree System(xii)	£170.21	£29.79	£200.00	o	o	o
Dual Band Integrated GSM Telephone with Handset	£425.53	£74.47	£500.00	o	o	o
Dual Band Integrated GSM Telephone with Handset and Volvo On Call(xi)	£680.85	£119.15	£800.00	o	o	o
CZIP (Clean Zone Interior Package)(xiii)	£102.13	£17.87	£120.00	o	o	o

	Basic £	VAT £	Rec Retail Price £	SE	SE LUX	R-DESIGN
<b>WINTER PACK</b> Heated Front Seats, Headlamp Cleaning System, Luxury Floor Mats and Heated Washer Nozzles	£382.98	£67.02	£450.00	o	n/a	u (£275)
Winter Pack with Active Bending Headlamps	£851.06	£148.94	£1,000.00	o	●	u (£825)
<b>FAMILY PACK</b> Integrated 2-Stage Booster Cushions x 2, Power Child Locks (Rear Doors) and Passenger Airbag Cut Off Switch	£221.28	£38.72	£260.00	o	o	o
<b>COMMUNICATIONS PACK</b> RTI Navigation System with RDS-TMC, Remote Control with Europe DVD Maps, PCC (Personal Car Communicator) with Heartbeat Sensor and Keyless Drive and Bluetooth® Handsfree System(xii)	£1,702.13	£297.87	£2,000.00	o	o	o
<b>DRIVER SUPPORT PACK (not 2.0, 2.0D, 2.0F, 2.5T and 2.5FT)</b> BLIS (Blind Spot Information System), ACC (Adaptive Cruise Control) with Distance Alert and Collision Warning with Auto Brake and LDW (Lane Departure Warning) with DAC (Driver Alert Control)(i)	£1,276.60	£223.40	£1,500.00	o	o	o
<b>SECURITY PACK</b> PCC (Personal Car Communicator) with Heartbeat Sensor and Keyless Drive, 360° Laminated Windows including Cargo Area (Front Side Windows are Water Repellent) and TPMS (Tyre Pressure Monitoring System)	£638.30	£111.70	£750.00	o	o	o



## What's your style?

At Volvo we know everyone is different. And that's why you can choose from a whole spectrum of colours for the exterior of your Volvo V70. Whatever your style, you'll find the perfect shade for you.



019 Black Stone



426 Silver metallic<sup>(1)</sup>

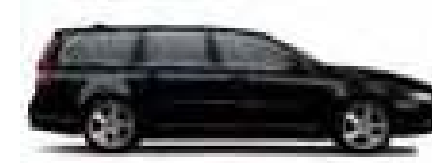

452 Black Sapphire metallic<sup>(1)</sup>



454 Ruby Red pearl

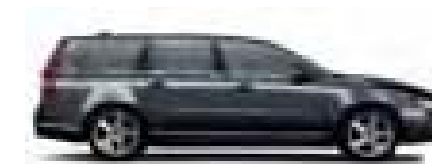

455 Titanium Grey pearl<sup>(1)</sup>

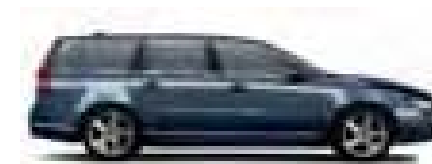

466 Barents Blue pearl<sup>(1)</sup>



467 Magic Blue pearl<sup>(1)</sup>

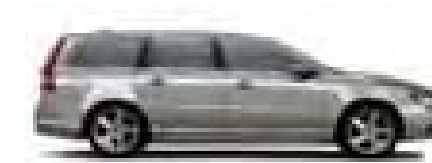

472 Oyster Grey pearl<sup>(1)</sup>



477 Inscription™ Electric Silver Coarse Flake metallic<sup>(1)</sup>



484 Seashell metallic<sup>(1)</sup>



485 Glacier Blue metallic<sup>(1)</sup>



492 Savile Grey pearl



493 Capar Green pearl



612 Passion Red<sup>(1)</sup>



614 Ice White<sup>(1)</sup>

NB It is not possible to reproduce exact original shades in printed matter. Please ask your dealer to show you samples.

<sup>(1)</sup> R-DESIGN only available with these colours.

# The wheels

And now we come to one of the most important parts of choosing your new Volvo V70. Volvo alloy wheels come in a variety of different styles, cuts and finishes – each with its own distinct character.

Your selection of alloy wheel can dramatically influence the exterior styling of your Volvo. What will you choose?



17" Canicula  
(Silver Bright)



18" Cratus  
(Silver Bright)

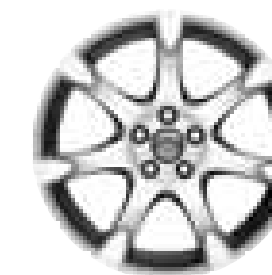

18" Fortuna  
(Diamond Cut/Graphite)

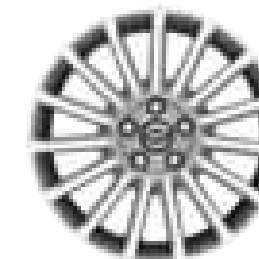

17" Regor  
(Silver Bright)

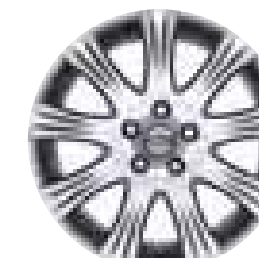

17" Cassini  
(Silver Bright)

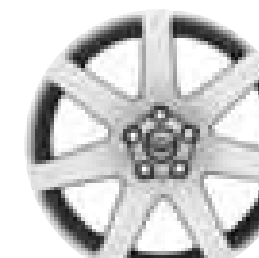

18" Venator  
(Silver Bright)

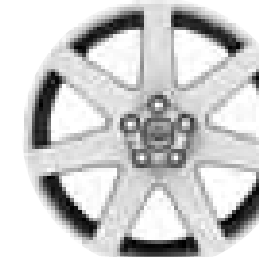

18" Venator  
(Chromed)

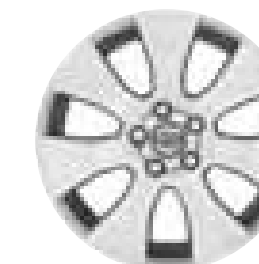

17" Spartes  
(Silver Stone)

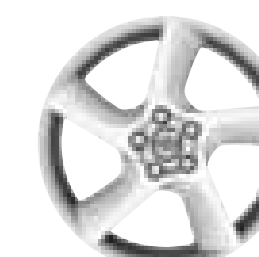

18" Odysseus  
(Silver Bright)

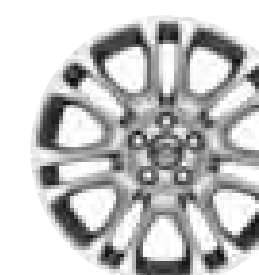

18" Zubra  
(Silver Bright)





# Bespoke tailoring from Volvo

The finest fabrics, superb stitching and minute attention to detail – whichever interior you choose for your Volvo V70 you'll be surrounded by luxury. How will you tailor yours?

## SUNDBY TEXTILE/T-TEC



Off Black (E500)



Mocca Brown (E514)

## VITTINGE LEATHER/TEXTILE



Off Black (E800)



Soft Beige (E812)

## LEATHER-FACED



Off Black (E100)



Soft Beige (E102)

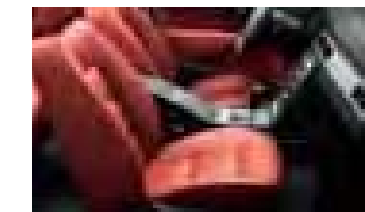

Cranberry (E105)



Off Black/Cream (EJ0E)

## RDESIGN LEATHER-FACED SPORTS



Quartz Grey (E108)



Soft Beige (E112)

NB It is not possible to reproduce exact original shades in printed matter. For full colour breakdown of upholstery and interior, please refer to the upholstery section on the next page.

### VENTILATED LEATHER-FACED



Off Black (E200)



Soft Beige (E202)



Quartz Grey (E208)



Soft Beige (E212)

### SOVEREIGN HIDE



Off Black (E400)



Soft Beige (E402)



Quartz Grey (E408)

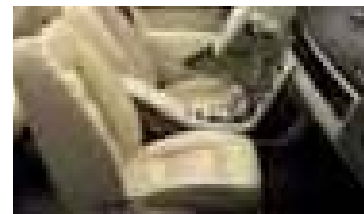

Soft Beige (E412)

UPHOLSTERY	Upholstery Code	Interior Colour	Upholstery Colour	Dashboard Top	Door Panel, Lower Dashboard & Upper Tunnel Console	Carpet & Lower Tunnel Console	Door Insert Colour	Headliner Colour
Sundby Textile/T-Tec	E500	Anthracite Black	Off Black	Off Black	Off Black	Off Black	Off Black	Soft Beige
	E514	Sandstone Beige	Mocca Brown	Espresso Brown	Soft Beige	Mocca Brown	Mocca Brown	Soft Beige
Vittinge Leather/Textile	E800	Anthracite Black	Off Black	Off Black	Off Black	Off Black	Off Black	Soft Beige
	E812	Sandstone Beige	Soft Beige	Espresso Brown	Soft Beige	Mocca Brown	Soft Beige	Soft Beige
Leather-faced	E100	Anthracite Black	Off Black	Off Black	Off Black	Off Black	Off Black	Soft Beige
	E102	Anthracite Black	Soft Beige	Off Black	Off Black	Off Black	Soft Beige	Soft Beige
	E105	Anthracite Black	Cranberry	Off Black	Off Black	Off Black	Cranberry	Soft Beige
	E108	Anthracite Black	Quartz Grey	Off Black	Off Black	Off Black	Quartz Grey	Quartz Grey
	E112	Sandstone Beige	Soft Beige	Espresso Brown	Soft Beige	Mocca Brown	Soft Beige	Soft Beige
Ventilated Leather-faced	E200	Anthracite Black	Off Black	Off Black	Off Black	Off Black	Off Black	Soft Beige
	E202	Anthracite Black	Soft Beige	Off Black	Off Black	Off Black	Soft Beige	Soft Beige
	E208	Anthracite Black	Quartz Grey	Off Black	Off Black	Off Black	Quartz Grey	Quartz Grey
	E212	Sandstone Beige	Soft Beige	Espresso Brown	Soft Beige	Mocca Brown	Soft Beige	Soft Beige
	Sovereign Hide	E400	Anthracite Black	Off Black	Off Black	Off Black	Off Black	Off Black
E402		Anthracite Black	Soft Beige	Off Black	Off Black	Off Black	Soft Beige	Soft Beige
E408		Anthracite Black	Quartz Grey	Off Black	Off Black	Off Black	Quartz Grey	Quartz Grey
E412		Sandstone Beige	Soft Beige	Espresso Brown	Soft Beige	Mocca Brown	Soft Beige	Soft Beige
<b>REDESIGN</b> Leather-faced Sports		EJ0E	Anthracite Black	Off Black/Cream	Off Black	Off Black	Off Black	Off Black



## Interior inlays

A selection of premium materials to complement your interior fabric.



Dark Finesline

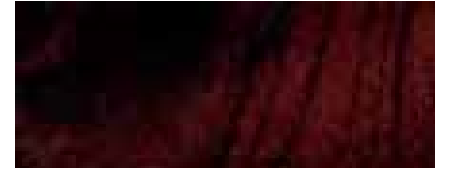

Walnut Wood

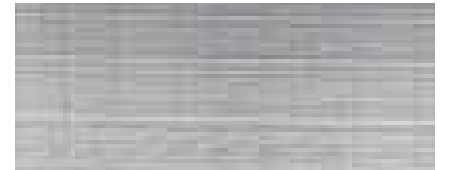

Cross Brushed Aluminium



Modern Wood



**REDESIGN** Aluminium

NB It is not possible to reproduce exact original shades in printed matter

# In fine detail

The nuts and bolts of your Volvo V70. Whatever you need to know about your new car – whether that's fuel consumption, CO2 emissions, top speed or boot space – you'll find it here.

ENGINE	2.0 Manual	2.5T	3.2 Geartronic	T6 AWD Geartronic	2.0D Manual	2.4D	D5	D5 AWD	2.0F Flexifuel Manual	2.5FT Flexifuel
Configuration	Transverse 16 valve	Transverse 20 valve	Transverse 24 valve	Transverse 24 valve	Transverse 16 valve	Transverse 20 valve	Transverse 20 valve	Transverse 20 valve	Transverse 16 valve	Transverse 20 valve
Cylinders	4	5	6	6	4	5	5	5	4	5
Engine capacity, cc	1999	2521	3192	2953	1997	2400	2400	2400	1999	2521
Bore x stroke, mm	87.5 x 83.1	83 x 93.2	84 x 96	82 x 93.2	85 x 88	81 x 93.2	81 x 93.2	81 x 93.2	87.5 x 83.1	83 x 93.2
Max. output ECE, PS kW rpm	145 107 6000	200 147 4800	238 175 6200	285 210 5600	136 100 4000	163 120 4000	185 136 4000	185 136 4000	145 107 6000	200 147 4800
Max. torque ECE, Nm rpm	190 4500	300 1500-4500	320 3200	400 1500-4800	320 2000	340 1750-2750	400 2000-2750	400 2000-2750	190 4500	300 1500-4500
Octane rating	95 RON unleaded <sup>(i)</sup>	95 RON unleaded <sup>(i)</sup>	95 RON unleaded <sup>(i)</sup>	95 RON unleaded <sup>(i)</sup>	Turbo Diesel	Turbo Diesel	Turbo Diesel	Turbo Diesel	95 RON unleaded <sup>(i)</sup> Bio-ethanol (E85)	95 RON unleaded <sup>(i)</sup> Bio-ethanol (E85)
Fuel system	Multipoint fuel injection	Multipoint fuel injection	Port fuel injection	Port fuel injection	Common rail direct injection	Common rail direct injection	Common rail direct injection	Common rail direct injection	Multipoint fuel injection	Multipoint fuel injection
Compression ratio	10.8:1	9.0:1	10.8:1	9.3:1	18.5:1	17.3:1	17.3:1	17.3:2	10.8:1	9.0:1

PERFORMANCE	2.0 Manual	2.5T Man Gt	3.2 Geartronic	T6 AWD Geartronic	2.0D Manual	2.4D Man Gt	D5 Man Gt	D5 AWD Man Gt	2.0F Flexifuel Manual	2.5FT Flexifuel Man Gt
Top speed (mph)	124	130 130	146	152	121	130 127	140 134	137 130	124	130 130
Acceleration 0-60 mph (sec)	11.5	7.6 8.0	7.8	6.7	10.9	9.4 10.0	8.4 8.9	8.7 9.3	11.5	7.6 8.0
0-62 mph (0-100 kmh) (sec)	12.1	8.1 8.5	8.4	7.2	11.4	9.9 10.5	8.9 9.4	9.1 9.7	12.1	8.1 8.5
Drag co-efficient	0.31	0.31	0.31	0.31	0.31	0.31	0.31	0.31	0.31	0.31

FUEL CONSUMPTION <sup>(i)(ii)(iii)</sup>	2.0 Manual	2.5T Man Gt	3.2 Geartronic	T6 AWD Geartronic	2.0D Manual	2.4D Man Gt	D5 Man Gt	D5 AWD Man Gt	2.0F Flexifuel Manual	2.5FT Flexifuel Man Gt
Urban mpg (l/100 km)	24.1 (11.7)	20.9 18.5 (13.5) (15.3)	18.3 (15.4)	16.9 (16.7)	37.7 (7.5)	32.8 28.0 (8.6) (10.1)	32.8 28.0 (8.6) (10.1)	29.7 25.9 (9.5) (10.9)	24.1 (11.7)	21.2 18.6 (13.3) (15.2)
Extra Urban mpg (l/100 km)	40.9 (6.9)	39.2 37.7 (7.2) (7.5)	36.7 (7.7)	34.9 (8.1)	56.5 (5.0)	49.6 45.6 (5.7) (6.2)	49.6 45.6 (5.7) (6.2)	46.3 43.5 (6.1) (6.5)	40.9 (6.9)	39.2 37.2 (7.2) (7.6)
Combined mpg (l/100 km)	32.8 (8.6)	29.7 27.2 (9.5) (10.4)	26.9 (10.5)	25.0 (11.3)	47.9 (5.9)	42.2 36.7 (6.7) (7.7)	42.2 36.7 (6.7) (7.7)	38.7 34.9 (7.3) (8.1)	32.8 (8.6)	30.1 27.2 (9.4) (10.4)
CO <sub>2</sub> g/km	206	227 248	251	270	157	178 203	178 203	194 214	206	224 247
VED (Vehicle Excise Duty) Band	F	G G	G	G	D	E F	E F	F F	F	F G

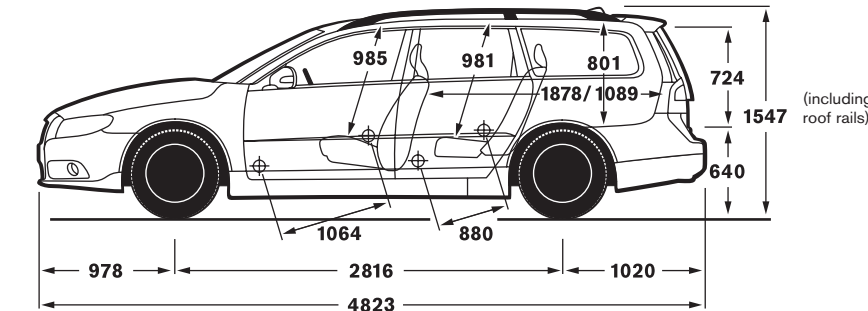
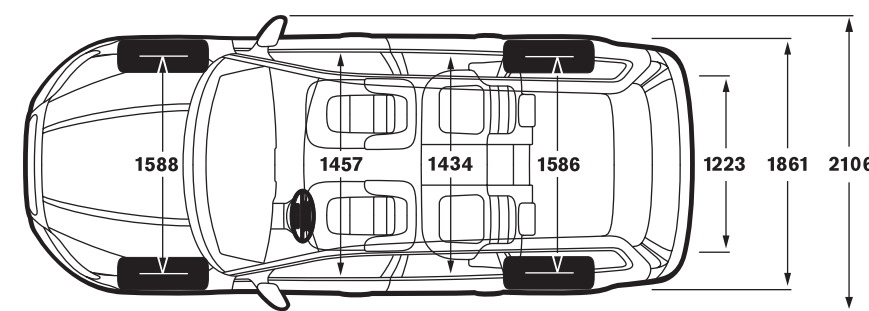

LUGGAGE COMPARTMENT	To Glass-line	To Roof
Volume (rear seats up – luggage area) litres (cu.ft)	575 (20.3)	815 (28.8)
Volume (rear seats down) litres (cu.ft)	840 (29.7)	1600 (56.5)

POWER STEERING SYSTEM	All models
(rack & pinion) Turning circle, m (ft) 225 – 245 (17" – 18") Section Tyres	11.2 – 12.2 (36'7" – 40'0")

	2.0 Manual	2.5T	3.2 Geartronic	T6 AWD Geartronic	2.0D Manual	2.4D	D5	D5 AWD	2.0F Flexifuel Manual	2.5FT Flexifuel
Brakes	16"	16.5"	16.5"	16.5"	16.5"	16.5"	16.5"	16.5"	16"	16.5"
Disc diameter front, mm	300 Ventilated	316 Ventilated	316 Ventilated	316 Ventilated	300 Ventilated	316 Ventilated	316 Ventilated	316 Ventilated	300 Ventilated	316 Ventilated
Disc diameter rear, mm	302	302	302	302	302	302	302	302	302	302
Transmission Manual	5 speed	6 speed	–	–	6 speed	6 speed	6 speed	6 speed	5 speed	6 speed
Transmission Geartronic	–	6 speed	6 speed	6 speed	–	6 speed	6 speed	6 speed	–	6 speed
Fuel tank volume litres (gallons)	70 (15.4)	70 (15.4)	70 (15.4)	70 (15.4)	70 (15.4)	70 (15.4)	70 (15.4)	70 (15.4)	70 (15.4)	70 (15.4)

INSURANCE GROUP	2.0 Manual	2.5T	3.2 Geartronic	T6 AWD Geartronic	2.0D Manual	2.4D	D5	D5 AWD	2.0F Flexifuel Manual	2.5FT Flexifuel
Volvo V70	13E	16E	17E	18E	13E	14E	15E	15E	13E	16E

E = Exceeds security requirements for model concerned and group rating has been reduced.

WEIGHTS	2.0 Manual	2.5T Man Gt	3.2 Geartronic	T6 AWD Geartronic	2.0D Manual	2.4D Man Gt	D5 Man Gt	D5 AWD Man Gt	2.0F Flexifuel Manual	2.5FT Flexifuel Man Gt
Min. kerb weight, kg (actual kerb weight dependent on spec.)	1638	1731 1747	1786	1883	1730	1757 1774	1757 1774	1836 1854	1638	1731 1747
Max. possible towing weight braked, kg	1500	1800 1800	1800	2000	1500	1500 1800	1800 2000	1800 2000	1500	1800 1800
Max. towing weight unbraked approx, kg <sup>(iv)</sup>	750	750 750	750	750	750	750 750	750 750	750 750	750	750 750
Max. towball weight, kg	75	75 75	75	90	75	75 75	75 90	75 90	75	75 75
Max. total weight, kg	2180	2260 2280	2310	2410	2270	2300 2310	2300 2310	2370 2390	2180	2260 2280
Max. roof load, kg	100	100 100	100	100	100	100 100	100 100	100 100	100	100 100
Max. payload, kg (dependent on spec)	542	529 533	524	527	540	543 536	543 536	534 536	542	529 533

- (i) For best performance and lowest fuel consumption 98 RON is recommended, 95 RON can be used for normal driving.
- (ii) The results do not express or imply any guarantee of the fuel consumption of a particular car as there are inevitable differences between individual cars of the same model.
- (iii) The Urban fuel consumption figure is based on typical city driving, including starting the car from cold. The Extra Urban figure is based on typical motorway driving and cruising. The Combined figure averages the consumption across both cycles.
- (iv) Unbraked towing weight must not exceed 50% of kerb weight up to a maximum of 700 kg.

## Notes

The weight of the vehicle will influence the level of CO<sub>2</sub> emitted. As a result, vehicles with higher levels of specification and factory fit options may emit higher levels of CO<sub>2</sub>. Once a vehicle has been built it will be given its own specific CO<sub>2</sub> emission on which Vehicle Excise Duty will be charged.

A weighbridge must be used to determine specific weights.

Data valid for manual transmission unless specified. Gt = Geartronic Automatic Transmission.

All measurements in mm.

The Max. output figures are quoted in PS (Pferdestärke), which is the metric equivalent of brake horsepower.

NB Some of the information in this price list may not be correct due to product changes which may have occurred since it was printed. Some of the equipment described or shown may now be available only at extra cost. Before ordering, please ask your Volvo dealer for the latest information. The manufacturer reserves the right to make changes at any time, without notice, to prices, colour, materials, specifications and models.

# Accessories from Volvo

Of course, your Volvo V70 won't be perfect until it's exactly how you want it. And that's why we offer a range of accessories so you can completely personalise your new car. **The prices quoted below exclude fitting costs and are correct at time of going to press** – please confirm the total cost with your local Volvo dealer.

ACCESSORIES	Basic £	VAT £	Rec Retail Price £
<b>EXTERIOR</b>			
Aluminium Bike Rack (down tube clamp)	£52.09	£9.12	£61.21
Bike Rack (servo lift)	£82.47	£14.43	£96.90
Bike Rack Cargo Area	£85.11	£14.89	£100.00
Bike Rack (towbar mounted and collapsible)	£282.17	£49.38	£331.55
Bike Carrier – extra bicycle towbar mounted	£69.20	£12.11	£81.31
Load Carrier – wing profile	£106.68	£18.67	£125.35
Mud Flaps Front, Mud Flaps Rear (price per pair)	£22.40	£3.92	£26.32
Roofbox – Sport Time 200 (440 litre volume) <sup>(i)</sup>	£153.56	£26.87	£180.43
Ski/Snowboard Carrier with Sliding Rail	£57.72	£10.10	£67.82
Towbar – Detachable type with 13 Pin Electrics <sup>(ii)</sup>	£382.98	£67.02	£450.00
Rear Park Assist and Front Park Assist – price for each from...	£158.98	£27.82	£186.80
Park Assist Camera (RTI required)	£382.78	£66.99	£449.77
Rear Spoiler	£236.75	£41.43	£278.18
<b>INTERIOR</b>			
Garmin Portable Sat Nav	£310.64	£54.36	£365.00
Twin Screen Rear Seat Entertainment System	£1,450.26	£253.80	£1,704.06
Boot Mat – rubber or textile/rubber reversible	£88.28	£15.45	£103.73
Cargo Area Divider	£90.15	£15.78	£105.93
Cooler/Hot Box (excludes power cable)	£69.46	£12.16	£81.62
Bluetooth® Hands Free System from...	£160.29	£28.05	£188.34
Load Liner – form moulded plastic for full cargo area	£64.68	£11.32	£76.00
iPod Interface	£238.30	£41.70	£280.00
USB Interface	£238.30	£41.70	£280.00
Combined USB/iPod Interface	£238.30	£41.70	£280.00
Rubber Floor Mats (set of four)	£51.51	£9.01	£60.52
Steel Safety Grille (behind second row of seats)	£119.15	£20.85	£140.00
Sunblind – rear door windows (pair)	£25.79	£4.51	£30.30
Sunblind – rear compartment (3 pieces)	£25.79	£4.51	£30.30
Table (rear centre armrest)	£17.36	£3.04	£20.40
<b>CHILD</b>			
Child Seat ISOFIX <sup>(iii)</sup>	£124.90	£6.25	£131.15
Infant Seat ISOFIX <sup>(iii)</sup>	£88.16	£4.41	£92.57
ISOFIX Base	£92.77	£16.23	£109.00
Child Booster Cushion	£30.09	£5.27	£35.36
Child Booster Backrest (to go with above)	£30.09	£5.27	£35.36

(i) Other roofboxes available – please ask your dealer for details.

(ii) Detachable 7 pin and Fixed 13 and 7 pin also available – please ask your dealer for details.

(iii) VAT on Child Seats is 5%.

For further information and a complete list of all Volvo Accessories, take a look at the Accessory website at [www.volvocars.co.uk/accessories](http://www.volvocars.co.uk/accessories) or visit your local Volvo dealer.

## Try a V70 for yourself with Volvo Rental

Why not hire a Volvo V70 – or any other Volvo – from Volvo Rental? You'll be guaranteed to drive a Volvo prepared to the highest standards by your local Volvo dealer. Call 0800 400 430 for more information today.



## The end is just the beginning

It's a simple idea; one point of contact for all your car ownership needs – whether it's about finding the right finance deal or who to contact in an emergency. To get the most out of owning your Volvo, trust Care by Volvo.

### MAKING LIFE EASIER

Owning a Volvo should be a safe and enjoyable experience. To ensure it stays that way, we're committed to providing you with the best in support for as long as you own one.

### STARTING OFF ON THE RIGHT FOOT

You might be surprised how easy and flexible financing can be. Our range of finance, service and insurance options allows you to budget around one key factor – your lifestyle.

### FINANCE

As part of Volvo, Volvo Car Finance has developed a series of funding plans that will provide you with maximum choice and flexibility when acquiring a Volvo®. For details of the current promotions available, please visit [www.volvocars.co.uk/financepromotions](http://www.volvocars.co.uk/financepromotions)

### INSURANCE

Volvo Owners Insurance is designed for Volvo drivers and because we know Volvos inside out, we can offer exactly the right tools and expertise, fitting only genuine Volvo parts by trained Volvo technicians<sup>(iii)</sup>. Because Volvo drivers have an excellent reputation, we can also offer extensive cover at a reasonable price<sup>(iii)</sup>.

Call now for your insurance quote on **0800 238 239**, quoting reference BROCH.



**WHAT NEXT?** If you'd like to find out more about the range of products and services that make up Care by Volvo, the story continues at [www.volvocars.co.uk](http://www.volvocars.co.uk). Alternatively you can contact your nearest Volvo dealer or request relevant brochures.

(i) Finance subject to status. Guarantees/indemnities may be required. Volvo Car Finance SL7 1YQ.

(ii) When using a Volvo approved repairer.

(iii) Volvo Owners Insurance is underwritten by Royal & Sun Alliance Insurance plc (No. 93792). Registered in England and Wales at St Mark's Court, Chart Way, Horsham, West Sussex RH12 1XL. Authorised and regulated by the Financial Services Authority. For your protection telephone calls will be recorded and may be monitored. All benefits are subject to qualifying status, terms and conditions, cover level and underwriting criteria. Service and repair benefits are subject to being carried out by a recommended repairer.

### SERVICE PROGRAMME

Your Volvo dealer has the unique know-how to tailor a service programme according to Volvo's strict recommendations and guarantees you years of safety and driving pleasure.

### VOLVO ON CALL

Subscribe to Volvo On Call and you'll never be completely on your own. It's a GPS-based communication system providing 24-hour access to both emergency and roadside assistance wherever you are. See the Volvo On Call brochure for more information.

### LOOKING AHEAD

You'll probably never find out just how good some of these services are. But should the unexpected happen, we'd like to think that you'd be even happier you chose a Volvo.

### ROADSIDE ASSISTANCE

Every new car comes with one year's Volvo Assistance cover. You'll enjoy free breakdown and recovery assistance, anywhere in Europe, 24 hours a day. You can even extend cover for £85 for one year or £155 for two years. Call Volvo Assistance on **08701 650 978**.

### WARRANTY

Every new Volvo comes with comprehensive protection. Our warranty covers the first three years or 60,000 miles, whichever comes first. There's a three year unlimited mileage warranty on the paintwork, and either eight or twelve years against rust perforation. If a component fails due to a defect or material fault, your dealer will swiftly rectify the problem, free of charge.

# Volvo. for life

For tax free sales, including Military, Diplomat and all other Export enquiries, contact Volvo Car UK Tourist & Diplomat Sales or Volvo Car UK British Military Sales on **01707 262 388** or e-mail to [vcukics@volvocars.com](mailto:vcukics@volvocars.com) or [bms@volvocars.com](mailto:bms@volvocars.com)

All 'On The Road' prices quoted in this price list include Volvo standard national delivery charge, inclusive of number plates at £480 and the VED (Vehicle Excise Duty) car tax. The 'On The Road' price also includes a £55 vehicle first registration fee (as set by the government – excludes Channel Islands and Isle of Man). Retail prices quoted do not include these additions.

**NB** Some of the information in this price list may not be correct due to product changes which may have occurred since it was printed. Before ordering, please ask your Volvo dealer for the latest information. The manufacturer reserves the right to make changes at any time, without notice, to prices, colour, materials, specifications and models.