



DRIVE-E

A factsheet on Volvo Cars' powertrain technology in the new Volvo S90

ELECTRIFICATION
CLEAN EFFICIENCY
RESPONSIVE POWER





Contents

| | |
|--|----|
| Introducing Drive-E | 3 |
| A modular approach | 4 |
| Petrol engine technology | 5 |
| - Supercharging and turbocharging | |
| - Direct injection | |
| Diesel engine technology | 9 |
| - Two-stage turbo | |
| - i-Art | |
| - PowerPulse - new technology launched in S90 | |
| Transmissions | 14 |
| - 8-speed Geartronic automatic | |
| - 6-speed manual | |
| All Wheel Drive | 16 |
| Twin Engine (PHEV) Technology | 17 |
| - Introducing Twin Engine Technology | |
| - Twin Engine T8 on SPA | |
| - Electric Rear Axle Drive (ERAD) | |
| - Crank-Integrated Starter Generator (C-ISG) | |
| - High Voltage Battery | |

Powertrain Technology

“Volvo Cars’ Drive-E powertrain technology is focused squarely on delivering responsive power, clean efficiency and an **exceptional driving experience**. We achieve this with our compactly-designed engines, advanced boosting solutions and a firm commitment to electrification across our portfolio,” says Dr Peter Mertens, Senior Vice President Research & Development at Volvo Car Group.



Volvo Cars’ powertrain technology is based on the concept of efficient power, without compromise. Our modular approach to powertrain engineering means that the same base engine architecture can deliver two distinctive powertrain attributes.

Clean Efficiency

All of our Drive-E powertrains are designed to improve fuel economy and reduce emissions. Our Drive-E four-cylinder powertrains have improved fuel efficiency by up to 35 per cent compared to our previous powertrain line-up while also delivering weight savings of up to 45 Kg.

Responsive Power

Our award-winning four-cylinder engines come with advanced boosting technology that delivers responsive power when desired through the innovative use of both turbo and supercharging.

Drive-E powertrain technology delivers the performance and drivability expected by our target customers.

Electrification

Volvo Cars’ engine technology, along with our new scalable platform **architecture SPA**, are designed with the future in mind.

Volvo Cars launched the world’s first diesel plug-in hybrid in 2012.

In 2015 we launched the world’s cleanest and most powerful 7-seat plug-in hybrid SUV: the XC90 T8

Twin Engine. Twin Engine technology will be available on all of Volvo Cars’ future product architectures.

Volvo Cars remains at the forefront of innovation in the field of powertrain engineering. We firmly believe that electrification and hybridization reflect the future.

Modularity

One of the developmental principles and key benefits behind our award-winning Drive-E powertrains is that they were designed to reduce complexity by using a compact, modular approach.

This effectively means that both diesel and petrol models share a common architecture and can therefore be produced on the same lines in our engine plants.

The efficient design of the architecture also means that a broad range of engine power variants can be achieved with bolt-on power boosting turbo- and superchargers, coupled with bespoke engine software.

Petrol

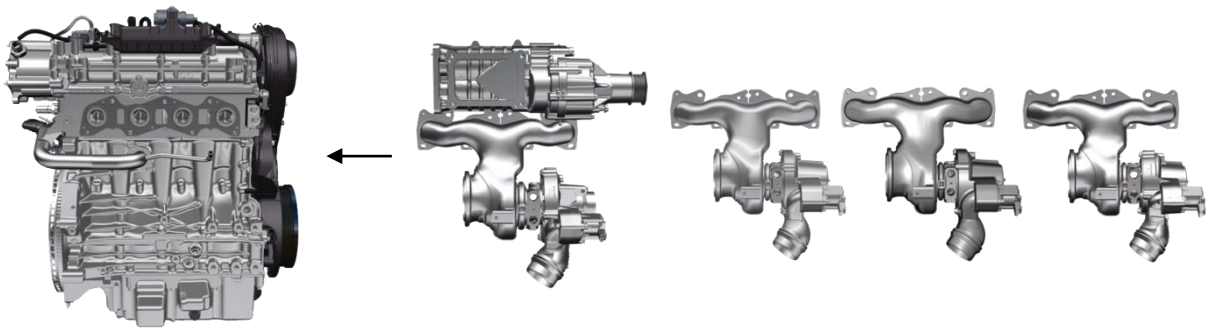

Diesel

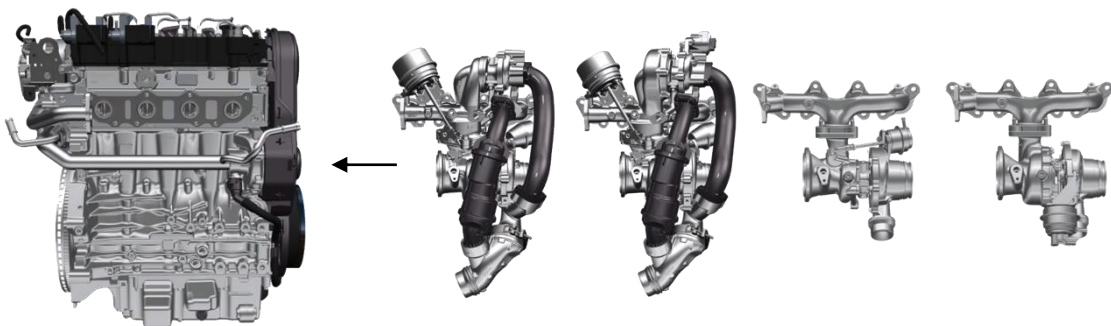

Petrol Engine Technology

Advanced Boosting

Volvo Cars has taken advanced boosting to a new level, using a modular based system that effectively offers Volvo owners a range of power levels and engine performance attributes. Advanced boosting means that our compact engines can deliver power levels equivalent to those of larger six- and eight-cylinder units. Advanced boosting also ensures high torque availability across a wider speed range.

We use state-of-the-art charging systems consisting of turbochargers and superchargers designed to our exacting specifications to deliver improved fuel economy, increased performance and drivability.

Supercharger & Turbos

Superchargers deliver low-end torque and response. Turbos deliver horsepower. Below 3500 rpm the supercharger and turbo are active. Above 3500 rpm, only the turbo is applied.

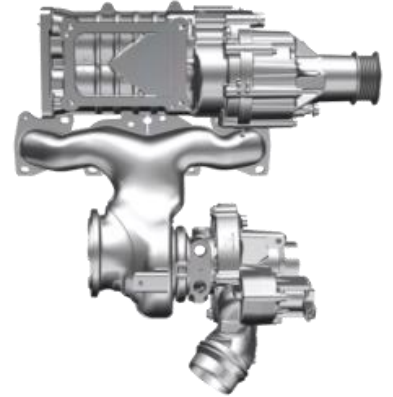

Supercharger & Turbo (T6)

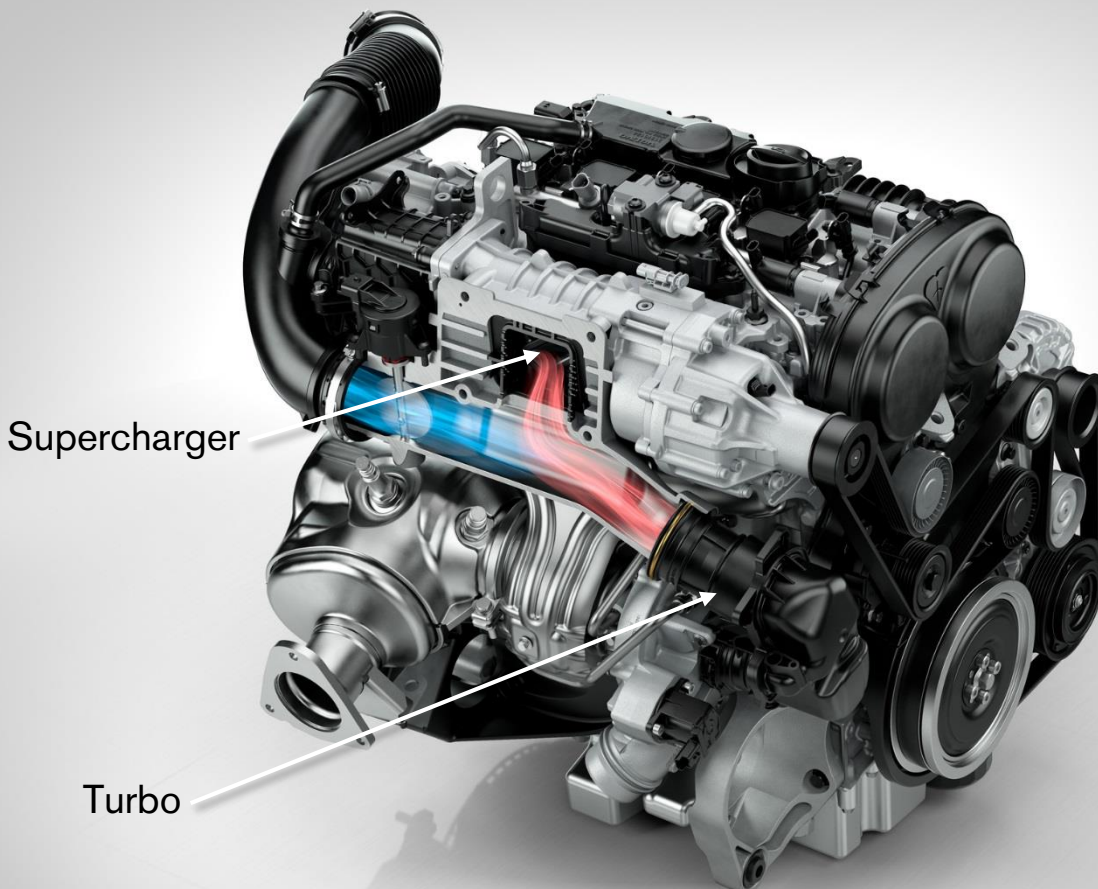

Petrol Engine Technology

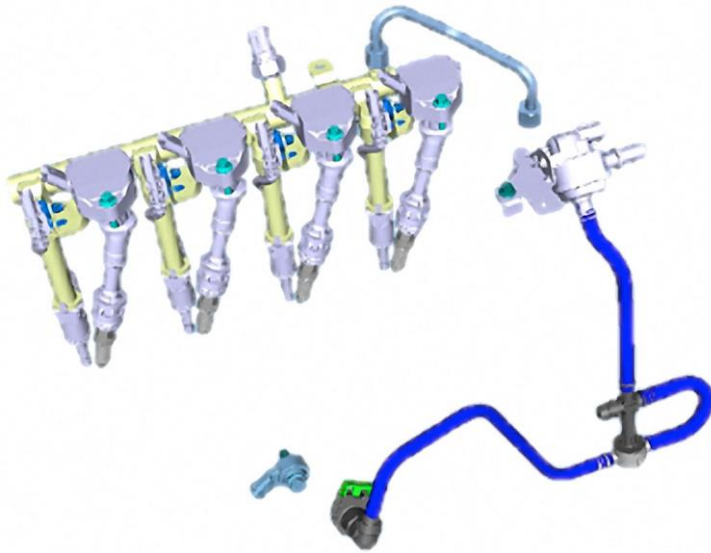

Advanced Combustion

The combustion system designed for the petrol engines is comprised of a centrally mounted spark plug and injector with a unique spray layout that provides a homogeneous air-fuel mixture.

This central **direct injection** technique enables:

- Stratified start and an effective catalyst heating mode that outperforms Port Fuel Injection (PFI) and side mounted Direct Injection engines, resulting in low fuel consumption and enabling Euro6 and LEVIII emission compliance.
- Improved low-end torque compared with PFI by using scavenging and charge cooling by direct fuel injection.

The intake ports are designed to generate a high

tumble motion, promoting the mixing of air and fuel during the intake stroke. In the succeeding compression stroke, this tumble motion is broken down into turbulence, accelerating the combustion speed. The combustion is therefore very stable, enabling a high degree of internal EGR, which minimizes pumping losses, hence reducing the fuel consumption. Special efforts were made to achieve a combustion system that is knock resistant. The cooling water jacket, intake ports, spray target and combustion chamber geometry were fine-tuned, enabling a fuel-efficient, high compression ratio of 10.8 for the gasoline T5 and 10.3 for the gasoline T6.

Petrol Engines

T6

| | |
|---|--|
| Displacement | 2.0l |
| Charging system | One supercharger + one turbo with waste gate |
| Balancer shafts | Yes |
| Engine structure | Light weight high-pressure die cast aluminium crank cases and bedplates with cast-in iron liners and nodular cast iron bearing reinforcements. |
| Crank system | Similar pistons i.e. forged steel crank shafts to minimise bearing sizes, different machining of the piston top for different compression ratios. Friction reduced by 50%, ring tangential load reduction with Physical Vapour Deposition-coating (PVC) on the top ring and new honing specification. Piston pins are coated with Diamond-like Carbon (DLC). |
| Cylinder head | The T6 utilizes a double water jacket design to aid cooling and flow. |
| Valve system | Direct-acting high-speed variable valve system with service-free DLC-coated mechanical tappets. Roller bearings on first cam bearing position to reduce friction. Cam phasers on both intake and exhaust camshafts enables flexibility in the trade-off between emissions, fuel consumption and drivability. |
| Oil system <small>(with variable oil pump)</small> | The oil pump is fully variable and the oil pressure is controlled by a solenoid actuator for friction reduction. |
| Cooling system / Thermal management | The petrol engines are equipped with a 400 W electrical water pump to reduce friction losses and create the possibility to control the coolant flow for fast engine warm-up and friction reduction |
| Combustion system | A centrally mounted spark plug and injector with a unique spray layout that provides a very homogeneous air-fuel mixture. |
| Exhaust gas after-treatment | Volvo's compact modular exhaust gas after-treatment system shows very low pressure drop and high uniformity qualities and shares a similar base design for both petrol and diesel applications. The petrols fulfill all Euro 6b/ULEV and PZEV requirements. |

Petrol Engines

T6 front



T6 back



Diesel Engine Technology

Advanced Boosting

Volvo Cars' modular approach to advanced boosting also applies to the diesel engines in the Drive-E powertrain line-up.

Consisting of a **serial sequential two-stage** turbo system, it is based on a refined version of the boosting technology first introduced in Volvo cars in 2008.

Once again, advanced boosting enables the delivery of increased power and drivability, but with lower fuel consumption. The two-stage turbo also allows both low and high-speed response.

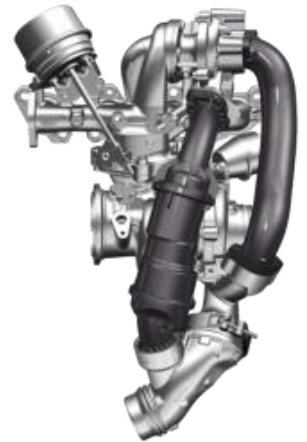

Two-stage Turbo (D4)

Two-stage Turbo

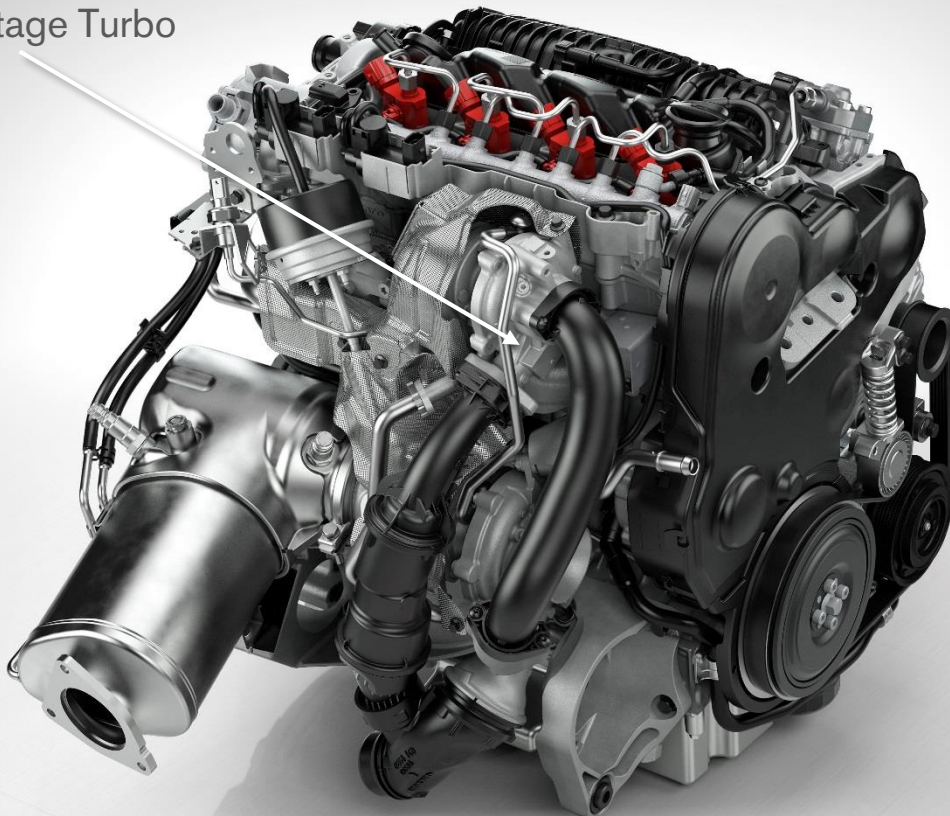

PowerPulse

New Innovation launched with S90

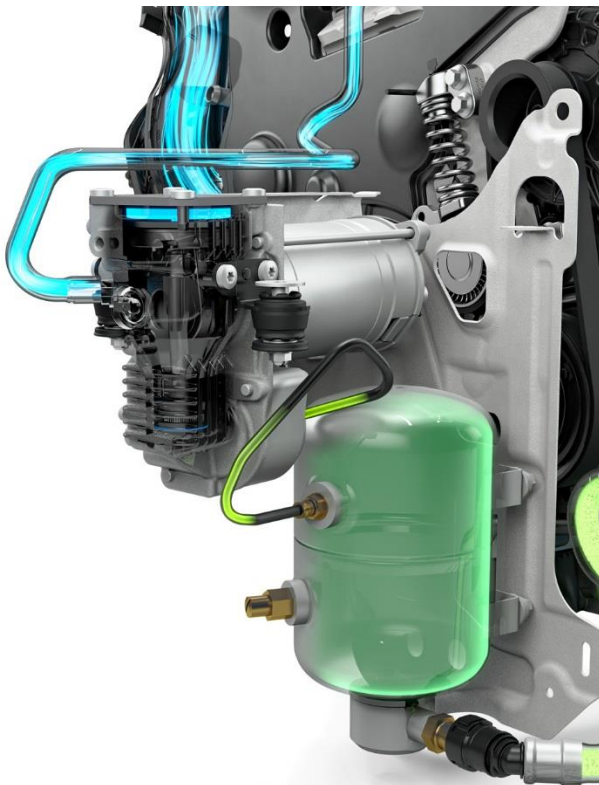

With PowerPulse, Volvo Cars has developed an innovative way of delivering instant turbo response in diesel engines providing a distinct performance feel that many car makers struggle to achieve in their diesel variants.

PowerPulse works by drawing air from the air filter via a compressor to a pressurised two-litre air tank.

When the driver wishes to accelerate quickly during launch and during low-speed driving, the air is fed by a valve into the exhaust manifold to feed the turbo. This has the effect of delivering a quick and responsive pulse of power.

The air in the tank is topped-up automatically, making sure that PowerPulse is always ready to deliver a new boost.

Volvo Cars is the only car maker currently using such technology in production cars.

PowerPulse will be available in the S90 on the Drive-E high performance diesel (D5) automatic powertrains (including AWD).

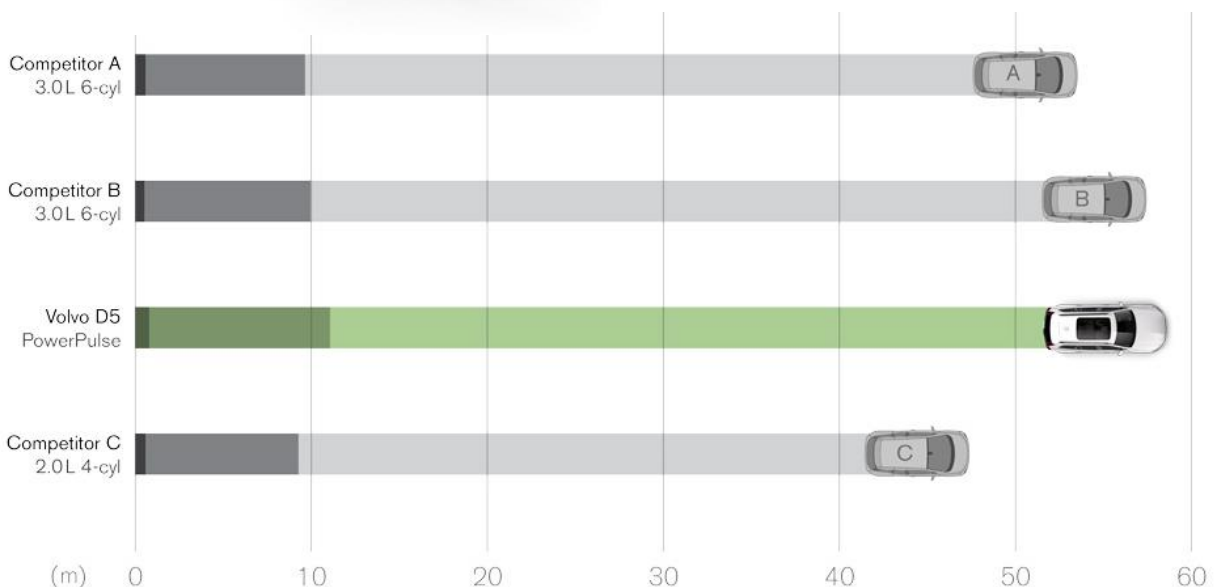

Diesel Engine Technology

Advanced Combustion

i-Art represents the latest diesel fuel system technology.

The system rail pressure of up to 2,500 bar is increased compared to previous systems of 1800 to 2000 bar. Thanks to a pressure sensor and an intelligent chip in each injector, it is possible to get vast and accurate feedback, resulting in much improved control of the injected fuel quantity.

This accurate and compensating injection system delivers up to 9 injections per combustion for precise combustion control. As each injector responds to real-time changes in its cylinder it means that the constantly variable injection can compensate for variations due to production and aging of the system.

This precise control of the combustion cycle means that consumption can be balanced to meet state of the art attribute levels and deliver up to 2 percent improved fuel efficiency. Volvo Cars was the first European car maker to introduce i-Art Technology in its cars.

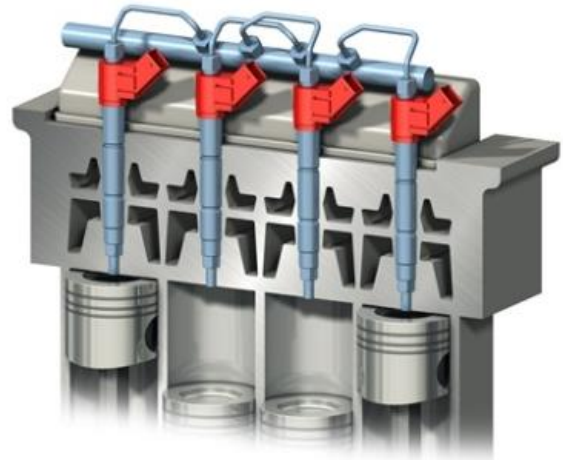
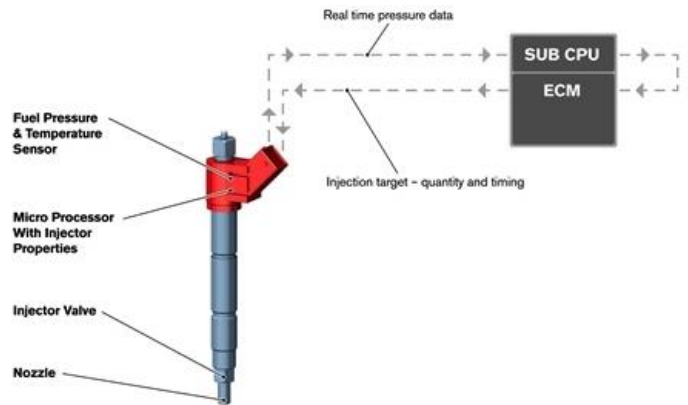

Irregular combustion (without i-Art)

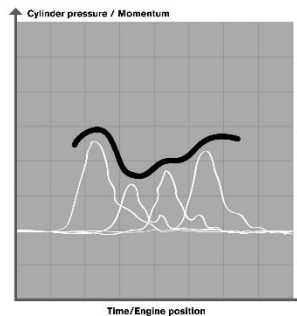

i-Art combustion - controlled and optimised

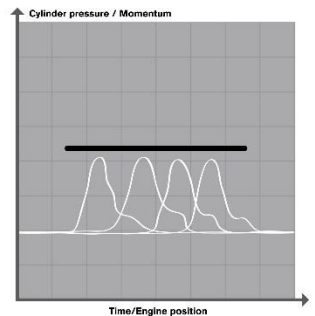

Diesel Engines

| | D4 | D5 |
|--|--|--|
| Displacement | 2.0l | 2.0l |
| Charging system | Series-sequential two-stage turbo | Series-sequential two-stage turbo with one VNT |
| Balancer shafts | Yes | Yes |
| Engine structure | High-pressure die cast aluminium crank cases and bedplates with cast-in iron liners and modular cast iron bearing reinforcements | |
| Crank system | Forged steel crank shafts to minimize bearing sizes. Friction reduction, 50% ring tangential load reduction with Physical Vapour Deposition-coating (PVC) on the top ring and new honing specification. Piston pins are coated with Diamond-like Carbon (DLC) + common design of the ring pack. The result is improved efficiency through friction reduction. | |
| Cylinders | Piston with cooled ring carrier for optimal cooling performance | |
| Cylinder head | Transverse cooling concept gives excellent and even cooling performance. | |
| Valve system | To cope with a peak firing pressure of 190 bar and high specific power, the coolant cores and the supporting structure for the fire deck were designed with great care. A new heat treatment was developed to improve the material strength and temperature limit. Forced air quenching is used to minimise residual material stress. This results in a significantly improved microstructure, with dendrite ARM spacing of less than 17 µm. The material specification is A319 T7. A classic roller finger follower valve system with hydraulic lash adjusters and steel-built camshafts for reduced weight and material hardness for the rolling contact. Positioning pins to the camshaft bearing caps assure alignment during machining and assembly, reducing friction. | |
| Oil system (with variable oil pump) | The oil pump is fully variable and the oil pressure is controlled by a solenoid actuator for friction reduction. | |
| Cooling system/ Thermal management | The outer cooling system is different for petrol and diesel cars because diesel engines have higher heat rejection at full load and lower heat rejection at part load and during warm-up. The diesel engines use a mechanical water pump. Flow control for fast engine heat-up is instead accomplished by pneumatic flow control valves. Heat transfer to the climate system is achieved through a separate electric pump. Efficient thermal management improves fuel economy and cabin comfort. | |
| Combustion system | The fuel injection system for the Drive-E diesel engines is a world first, with the combination of 2500 bar maximum injection pressure and closed-loop fuel quantity control, called intelligent Accuracy Refinement Technology (i-ART). | |
| Exhaust gas after-treatment | Volvo's compact modular exhaust gas after-treatment system (LNT and DPF) shows very low pressure drop and high uniformity qualities and shares a similar base design for both petrol and diesel applications, for the diesels fulfilling all Euro 6b requirements. | |

Diesel Engines

D5



D4



Transmissions

8-speed automatic



- Best in class efficiency
- Quick and smooth shifting
- Converter technology for powerful launches
- High torque capacity considering small size and low weight
- Start-stop technology (electric oil pump keep transmission ready for re-start)

The Volvo S90 eight-speed planetary automatic transmission is a vital part of Drive-E powertrain technology.

The number of gears means that the engine's torque and power band can be utilized more efficiently.

Two of the gears are 'overdrives', which save fuel when cruising at constant speeds.

The Lock-up (LU) system is comprised of the latest NVH damping technology (pendulum damper for diesels and super long travel damper for the petrol engine). This enables frequent use of LU and allows the engine to run on low revs for best fuel economy.

In the T8 Twin Engine variant, paddles shifters enable downshifting. This variant has a unique engine-braking mode. The maximum torque level is also increased to enable better use of the C-ISG for performance boosting purposes.

Transmissions

6-speed Manual



The manual gearbox is a new generation of our well proven six-speed manual gearbox.

New gear sets and efficiency work have made it smoother and even more fuel efficient.

Combined with the new external shifter design, the gear positions are more exacting and solid.

This gearbox will also be available in an All-Wheel Drive application for products based on our Scalable Product Architecture (SPA).

- 450Nm transmission
- Light weight ~54 kg
- New optimized gear sets and final drives to provide good drivability and fuel economy.

All-Wheel Drive



ALL-WHEEL DRIVE

The all-wheel drive variants of the Volvo S90 have a very efficient type of four-wheel drive system. A compact and lightweight coupling (BorgWarner Gen. 5) distributes the engine's power between the front and rear wheels. Under normal, dry conditions practically all of the power is distributed to the front wheels. The system constantly calculates the need for torque to the rear wheels and can instantly redistribute up to 50 per cent of the engine's torque to the rear wheels. When at a standstill, full all-wheel drive is always engaged to prepare for maximum traction during acceleration.



Twin Engine Technology

Plug-in hybrids

“Volvo Cars has made a clear commitment to electrification across our entire product range. Our Twin Engine technology is a confident first step forward. This technology delivers a no compromise balance of clean, efficient performance and exceptional driving pleasure. It is all about using the latest available technology to address unmet consumer needs,” says *Dr Peter Mertens, Senior Vice President Research & Development at Volvo Car Group.*

PURE



HYBRID



POWER



Twin Engine Definition

Volvo’s Twin Engine technology is essentially a combination of an internal combustion engine and electric power. Electric energy from the grid can be stored in a High Voltage Battery. The technology is more commonly known as Plug-in Hybrid Technology (PHEV).

Volvo’s technology is designed to deliver three cars experiences in one.

- **PURE** – where the car runs on electric power alone.
- **HYBRID** – where an optimal combination of the engine and electric machine propels the cars in a balanced and sustainable way.
- **POWER** – where all available power is used to deliver maximum performance.

Volvo’s Twin Engine set-up means that the high voltage battery is positioned in the tunnel console for maximum safety and also improved weight distribution that gives an improved driving experience.

Twin Engine technology delivers a no compromise mix of performance, driving pleasure, efficiency interior, cargo space and flexibility.



Twin Engine Technology (SPA)

T8 AWD

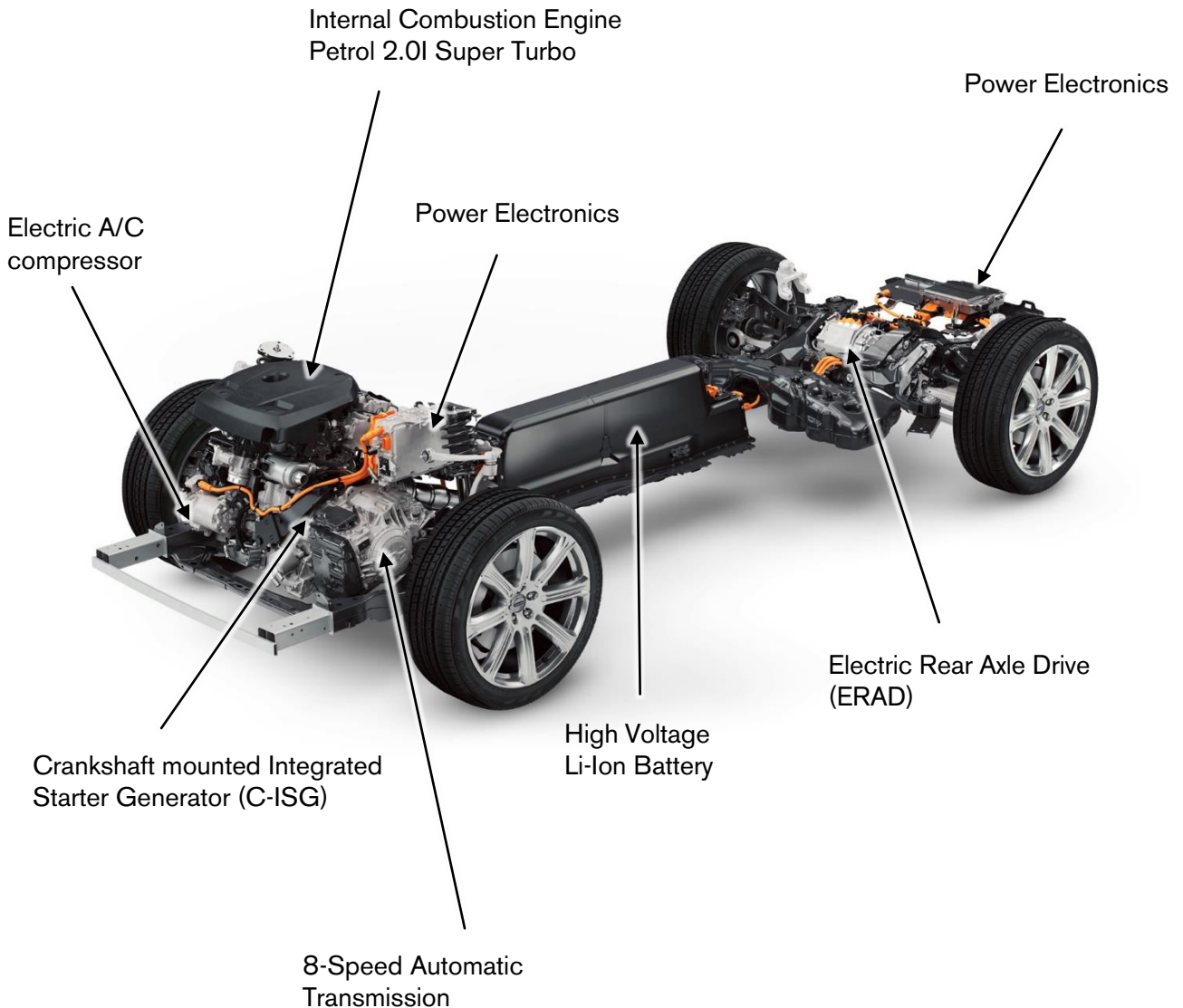

Twin Engine Technology (SPA)

Electric Rear Axle Drive

- Propels vehicle in electric mode
- Provides electric boost torque and power during acceleration
- Provides electric all wheel drive functionality
- Performs brake energy recuperation

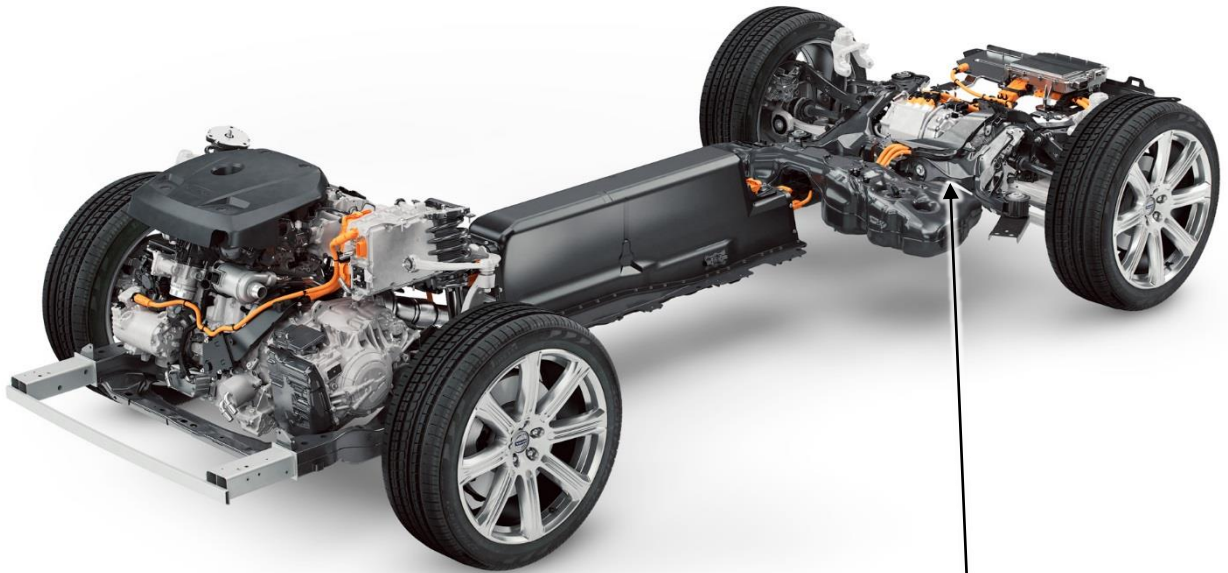

Permanent Magnet Synchronous
Machine

Peak power: 65 kW

Peak torque 240 Nm

Weight: 34 kg

Cooling: Water cooled stator

Twin Engine Technology (SPA)

Crank-Integrated Starter Generator

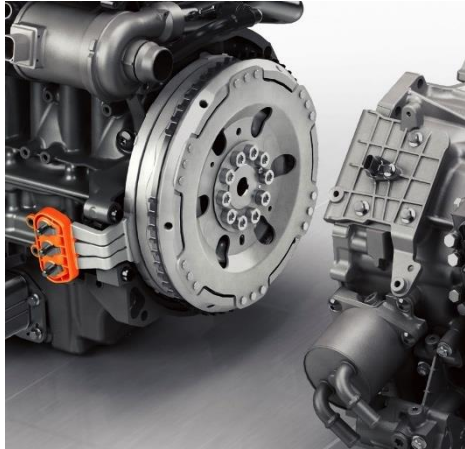

- Charges the battery
- Starter for the combustion engine
- Can support the combustion engine with electric boost power

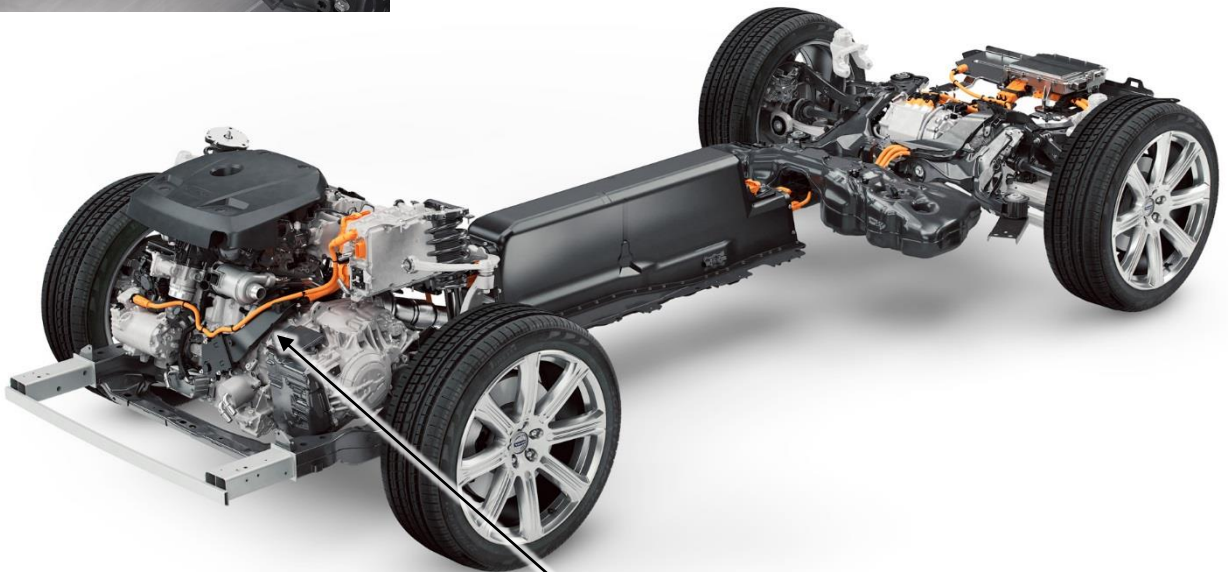

Permanent Magnet Synchronous Machine

Peak power: 34 kW

Peak torque: boost 150 Nm, cold crank = 180 Nm 240 Nm

Weight: 18kg

Cooling: Water cooled

Twin Engine Technology (SPA)

High Voltage Battery

The function of the high voltage battery is to store energy. It receives energy from electric grid charging and also from regenerative braking of the vehicle or from the C-ISG.

The high voltage battery delivers power for pure electric drive and also to run the electric air conditioning for pre-climatisation of the passenger compartment.



96 Li-ion cells
270-400V
9.2 kWh (nominal)
6.7 kWh (usable)
Lithium Manganese Oxide – Nickel
Manganese Cobalt/Graphite
Weight: 113 kg (excluding coolant)
Manual service disconnect

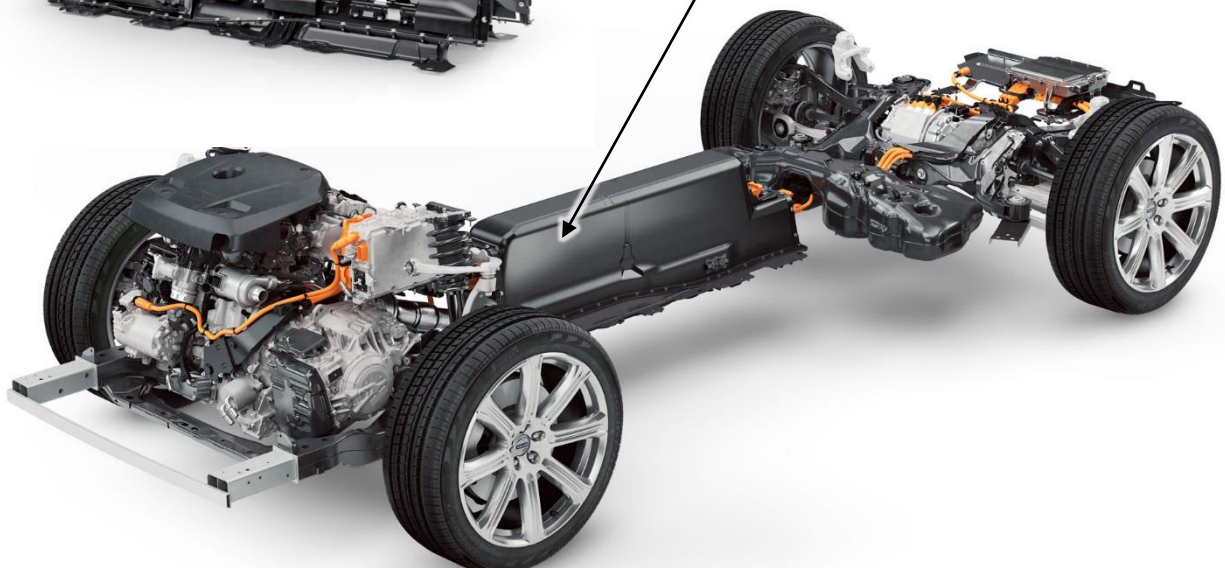

DRIVE-E

Efficient Power, No Compromise



V O L V O

Published by Volvo Car Group © 2015. All rights reserved. S90 Launch Drive-E factsheet Dec 2015