

# VOLVO S80

PRICE AND SPECIFICATION



# Create your perfect Volvo S80

Congratulations. You're only a few steps away from your perfect Volvo S80. This price list contains everything you need to create the car that's exactly right for you.

From selecting the right package and choosing from a range of class leading engines, through to picking the perfect colour and adding the finishing touches, you're in complete control. You'll also find full engine details and in-depth technical specifications to help you make the most informed choice.

Whatever you decide, you'll be choosing a car that epitomises modern Scandinavian luxury with beautiful yet functional design. Equal parts luxury express and sports saloon, when the mood takes you, it can justifiably lay claim to being the perfectly balanced automobile.





## S80 SE

The SE aims to spoil. Its luxurious interior boasts supportive seats with Sundby Textile/T-Tec upholstery – electronically adjustable for the driver. Then there's the 8 speaker High Performance audio system with 160W output and intuitive features such as automatic rain sensor and autodimming rear view mirror with compass. On the outside, 17" Regor alloy wheels and colour co-ordinated front spoiler and side mouldings make sure your presence doesn't go unnoticed.

## S80 SE LUX

The SE Lux model is the ultimate in luxury. Leather-faced upholstery, walnut wood inlays, heated and powered front seats and luxury floor mats further enhance the luxurious interior. 17" Canicula alloy wheels, Active Bending headlamps and rear park assist offer both style and protection.

## S80 EXECUTIVE

The Executive is the ultimate in Volvo luxury. Its refined exterior boasts a chrome finish in the front spoiler and fog light surround, side mouldings and below the rear lights, as well as elegant 18" Balius alloy wheels. Inside the cabin, the unique walnut wood executive console extends a warm welcome and the Executive Ventilated Soft Leather upholstery with massage function and contrasting seams and piping adorns the seats and armrests. Additional features include a fridge and our Premium Sound audio system with Dolby Pro Logic II Surround Sound™ and 12 Dynaudio loudspeakers.

## S80 SE SPORT

The SE Sport model combines the luxury features of the SE with sports styling and handling enhancements. Speed dependent power steering and Volvo's active chassis system, Four-C, both have three user settings to allow you to set up the car exactly to your liking. 18" Venator alloy wheels enhance the handling and visual presence while leather-faced ventilated powered front seats offer seven cooling and heating settings.

# On the road

How much will it cost to get behind the wheel of your own Volvo S80? Simply decide which model variant and engine type are right for you and then take a look at the full price list below.

## S80 SE

	Basic £	VAT £	Rec Retail Price £	On the Road Price £
<b>PETROL</b>				
2.0 (145 PS) SE	£19,319.15	£3,380.85	£22,700.00	£23,495.00
2.5T (200 PS) SE	£20,851.06	£3,648.94	£24,500.00	£25,295.00
3.2 (238 PS) SE Geartronic	£24,255.32	£4,244.68	£28,500.00	£29,485.00
V8 AWD (315 PS) SE Geartronic	£31,063.83	£5,436.17	£36,500.00	£37,485.00
<b>DIESEL</b>				
2.0D (136 PS) SE	£20,097.87	£3,517.13	£23,615.00	£24,345.00
2.4D (163 PS) SE	£21,374.47	£3,740.53	£25,115.00	£25,870.00
D5 (185 PS) SE	£22,225.53	£3,889.47	£26,115.00	£26,870.00
<b>FLEXIFUEL</b>				
2.0F (145 PS) SE	£19,574.47	£3,425.53	£23,000.00	£23,795.00
2.5FT (200 PS) SE	£21,106.38	£3,693.62	£24,800.00	£25,595.00

## S80 SE LUX

	Basic £	VAT £	Rec Retail Price £	On the Road Price £
<b>PETROL</b>				
2.0 (145 PS) SE Lux	£21,744.68	£3,805.32	£25,550.00	£26,345.00
2.5T (200 PS) SE Lux	£23,276.60	£4,073.40	£27,350.00	£28,145.00
3.2 (238 PS) SE Lux Geartronic	£26,680.85	£4,669.15	£31,350.00	£32,335.00
V8 AWD (315 PS) SE Lux Geartronic	£33,489.36	£5,860.64	£39,350.00	£40,335.00
<b>DIESEL</b>				
2.0D (136 PS) SE Lux	£22,523.40	£3,941.60	£26,465.00	£27,195.00
2.4D (163 PS) SE Lux	£23,800.00	£4,165.00	£27,965.00	£28,720.00
D5 (185 PS) SE Lux	£24,651.06	£4,313.94	£28,965.00	£29,720.00
<b>FLEXIFUEL</b>				
2.5FT (200 PS) SE Lux	£23,531.91	£4,118.09	£27,650.00	£28,445.00



## S80 EXECUTIVE

	Basic £	VAT £	Rec Retail Price £	On the Road Price £
<b>PETROL</b>				
3.2 (238 PS) Executive Geartronic	£33,489.36	£5,860.64	£39,350.00	£40,335.00
V8 AWD (315 PS) Executive Geartronic	£40,297.87	£7,052.13	£47,350.00	£48,335.00
<b>DIESEL</b>				
D5 (185 PS) Executive Geartronic	£32,651.06	£5,713.94	£38,365.00	£39,120.00

## S80 SE SPORT

	Basic £	VAT £	Rec Retail Price £	On the Road Price £
<b>PETROL</b>				
2.0 (145 PS) SE Sport	£21,787.23	£3,812.77	£25,600.00	£26,395.00
2.5T (200 PS) SE Sport	£23,319.15	£4,080.85	£27,400.00	£28,195.00
3.2 (238 PS) SE Sport Geartronic	£26,723.40	£4,676.60	£31,400.00	£32,385.00
V8 AWD (315 PS) SE Sport Geartronic	£33,531.91	£5,868.09	£39,400.00	£40,385.00
<b>DIESEL</b>				
2.0D (136 PS) SE Sport	£22,565.96	£3,949.04	£26,515.00	£27,245.00
2.4D (163 PS) SE Sport	£23,842.55	£4,172.45	£28,015.00	£28,770.00
D5 (185 PS) SE Sport	£24,693.62	£4,321.38	£29,015.00	£29,770.00
<b>FLEXIFUEL</b>				
2.0F (145 PS) SE Sport	£22,042.55	£3,857.45	£25,900.00	£26,695.00

# The right equipment

It's essential that your Volvo comes equipped with everything you need. Below you'll find the standard equipment lists for each model variant, plus optional equipment to personalise your Volvo S80. And as you'd expect, there is an array of industry-leading, cutting edge safety innovations.

<b>STANDARD EQUIPMENT - SAFETY &amp; SECURITY</b>	SE	SE LUX	EXECUTIVE	SE SPORT
Dual Stage Driver and Passenger Airbags	•	•	•	•
SIPS (Side Impact Protection System)	•	•	•	•
Dual Chamber SIPS Airbags	•	•	•	•
IC (Inflatable Curtain)	•	•	•	•
WHIPS (Whiplash Protection System)	•	•	•	•
ABS (Anti-lock Brake System) and FBS (Fading Brake Support) with HBA (Hydraulic Brake Assist), OHB (Optimised Hydraulic Brakes), EBD (Electronic Brake Distribution) and RAB (Ready Alert Brakes)	•	•	•	•
DSTC (Dynamic Stability and Traction Control)	•	•	•	•
5 Three Point Seat Belts	•	•	•	•
Seat Belt Pre-tensioners (Front and Rear)	•	•	•	•
Head Restraints - All 5 Seats	•	•	•	•
ISOFIX Attachment (Rear Seats)	•	•	•	•
Anti-theft Alarm including Immobiliser, Volume Sensor and Level Sensor	•	•	•	•
Key Integrated Remote Control Central Locking including Fuel Flap with Deadlocking System and Auto Open/Close Windows/Sunroof	•	•	•	•
Tinted Windscreen	•	•	•	•
Water Repellent Front Side Windows	•	•	•	•
PCC (Personal Car Communicator) with Heartbeat Sensor and Keyless Drive	•	•	•	•
Visible VIN Plate	•	•	•	•
Day Running Lights	•	•	•	•
Headlamp Levelling System	•	•	•	•
Adaptive Brake Lights including High Level LED Brake Light	•	•	•	•
Power Parking Brake	•	•	•	•
Side Marker Illumination	•	•	•	•
Home Safe and Approach Lighting	•	•	•	•
IDIS (Intelligent Driver Information System)	•	•	•	•
Warning Triangle	•	•	•	•

<b>STANDARD EQUIPMENT - EXTERIOR</b>	SE	SE LUX	EXECUTIVE	SE SPORT
Metallic/Pearlescent Paint			•	
17" Regor Alloy Wheels (Silver Bright) - 225/50 R17 W Tyres	•			
17" Meissa Alloy Wheels (Silver Bright) - 245/45 R17 W Tyres (V8 AWD Only)	•	•		
17" Canicula Alloy Wheels (Silver Bright) - 225/50 R17 W Tyres		•		
18" Venator Alloy Wheels (Silver Bright) - 245/40 R18 Y Tyres				•
18" Balius Alloy Wheels - 245/40 R18 Y Tyres				•
Locking Wheel Nuts	•	•	•	•
Tyre Sealant Kit	•	•	•	•
Active Bending Headlamps		•	•	•
Headlamp Cleaning System		•	•	•
Autofolding Power Door Mirrors with Ground Lights	•	•	•	•
Heated Washer Nozzles		•	•	•
Power Adjustable and Heated Door Mirrors	•	•	•	•
Front Fog Lights	•	•	•	•
Rain Sensor - Automatic Windscreen Wiper Activation	•	•	•	•
Grey Sill Covers and Stainless Steel Step Covers	•	•	•	•
Colour Co-ordinated Bumpers and Door Mirrors	•	•	•	•
Colour Co-ordinated Lower Door and Bumper Mouldings	•	•	•	•
Chromed Sections on Air Intake, Fog Light Surround, Lower Door Moulding and Rear Light Eyeliner			•	
Rear Park Assist		•	•	
Front Park Assist			•	
Exterior Executive Badge			•	
Active Four-C Chassis (Continuously Controlled Chassis Concept)				•
Electronic All Wheel Drive System with Instant Traction™ (Haldex Coupling) (V8 AWD Only)	•	•	•	•

<b>STANDARD EQUIPMENT - INTERIOR</b>	SE	SE LUX	EXECUTIVE	SE SPORT
ECC (Electronic Climate Control) with AGS (Air Quality System) and Pollen Filter	•	•	•	•
B Pillar Ventilation	•	•	•	•
Information Centre	•	•	•	•
Cruise Control	•	•	•	•
Speed Dependent Steering System with 3 Settings (Standard SE Sport and V8 AWD only)	•	•	•	•
Front and Rear Power Windows	•	•	•	•
Illuminated Driver and Passenger Vanity Mirrors	•	•	•	•
Front and Rear Reading Lights	•	•	•	•
Autodimming Rear View Mirror with Compass	•	•	•	•
Front and Rear Centre Armrest with Cupholders	•	•	•	•
Grocery Bag Holder	•	•	•	•
12V Socket (Front and Rear Tunnel Console/Cargo Area)	•	•	•	•
Power Driver's Seat with Seat Memory	•	•	•	•
Power Passenger Seat		•	•	•
Heated Front Seats		•	•	•
Heated Rear Seats			•	•
Height Adjustable Driver and Passenger Seats with Lumbar Support	•	•	•	•
Forward Folding Front Passenger Seat	•	•	•	•
Power Folding Rear Headrests		•	•	•
Leather Steering Wheel and Gear Knob (Walnut Wood Gear Knob - Executive)	•	•	•	•
Steering Wheel Remote Audio Controls	•	•	•	•
Silver Chronograph Instrument Dials (V8 Only)	•	•	•	•
Chrome Rotary Knobs, Air Vents and Mannequin	•	•	•	•
Height and Reach Adjustable Steering Column	•	•	•	•
Cross Brushed Aluminium Trim	•			•
Walnut Wood Trim		•	•	
Walnut Wood in Panels, Outer Centre Console and Gear Knob Inserts			•	
Sundry Textile/Tec Upholstery	•			
Leather-faced Upholstery		•		
Ventilated Leather-faced Upholstery				•
Executive Ventilated Soft Leather Upholstery with Massage Function and Door Inserts including Extra Padded Front Door Armrests			•	
Luxury Floor Mats		•		
Executive Luxury Floor Mats with Contrast Piping			•	
High Performance Sound Audio System - 1 x CD/Radio, 4 x 40W Amplifier, Aux Input (MP3/WMA Compatible) and 8 Speakers	•	•		•
Dynaudio Premium Sound Audio System - 6 x CD/Radio with Dolby Pro Logic II Surround Sound <sup>(i)</sup> , 5 x 130W Amplifier, Aux Input (MP3/WMA Compatible) and 12 Dynaudio Speakers			•	
Rear Seat Audio Console with Headphone Sockets x 2			•	
RTI Navigation System with RDS-TMC, Remote Control with Europe DVD Maps (not 2.0D)	•	•		•
Refrigerator in Rear Centre Armrest - 2 x Glasses and Bottle Opener			•	
Sunglasses Holder			•	

<sup>(i)</sup> Dolby and Pro Logic Surround Sound™ are trademarks of Dolby Laboratories Licensing Corporation.



OPTIONAL EQUIPMENT – SAFETY & SECURITY	Basic £	VAT £	Rec Retail Price £	SE	SE LUX	EXECUTIVE	SE SPORT
BLIS (Blind Spot Information System)	£382.98	£67.02	£450.00	o	o	o	o
Passenger Airbag Cut Off Switch	£21.28	£3.72	£25.00	o	o	o	o
PCC (Personal Car Communicator) with Heartbeat Sensor and Keyless Drive	£425.53	£74.47	£500.00	o	o	•	o
ACC (Adaptive Cruise Control) with Distance Alert and Collision Warning with Auto Brake (not 2.0/2.0D/2.0F/2.5FT and 2.5T) <sup>(i)</sup>	£1,106.38	£193.62	£1,300.00	o	o	o	o
Laminated Side Windows and Water Repellent Front Side Windows	£255.32	£44.68	£300.00	o	o	o	o
LDW (Lane Departure Warning) with DAC (Driver Alert Control) <sup>(i)</sup>	£425.53	£74.47	£500.00	o	o	o	o
IR (Infrared) Reflective Glass and Graduated Tinted Windscreen	£127.66	£22.34	£150.00	o	o	o	o
Private Locking	£21.28	£3.72	£25.00	o	o	o	o
Power Child Locks (Rear Doors)	£63.83	£11.17	£75.00	o	o	o	o
Integrated Child Seat (Rear Centre Armrest)	£110.64	£19.36	£130.00	o	o	n/a	o
Homelink	£42.55	£7.45	£50.00	o	o	o	o
First Aid Kit	£21.28	£3.72	£25.00	o	o	o	o

OPTIONAL EQUIPMENT – EXTERIOR	Basic £	VAT £	Rec Retail Price £	SE	SE LUX	EXECUTIVE	SE SPORT
Black Paint (Solid)	£212.77	£37.23	£250.00	o	o	n/a	o
Metallic/Pearlescent Paint	£510.64	£89.36	£600.00	o	o	•	o
Inscription™ Paint	£659.57	£115.43	£775.00	o	o	u (£175)	o
17" Regor Alloy Wheels (Silver Bright) – 225/50 R17 W Tyres (Not V8)	–	–	–	•	nco	n/a	n/a
17" Canicula Alloy Wheels (Silver Bright) – 225/50 R17 W Tyres (Not V8)	–	–	–	nco	•	n/a	n/a
17" Spartes Alloy Wheels (Silver Bright) – 225/50 R17 W Tyres	–	–	–	nco	nco	n/a	n/a
17" Cassini Alloy Wheels – 225/50 R17 Tyres (Not V8)	–	–	–	nco	nco	n/a	n/a
18" Venator Alloy Wheels (Silver Bright) – 245/40 R18 Y Tyres (Not 2.5FT)	£553.19	£96.81	£650.00	o	o	n/a	•
18" Zebra Alloy Wheels (Silver Bright) – 245/40 R18 Y Tyres (Not 2.5FT)	£553.19	£96.81	£650.00	o	o	n/a	nco
18" Odysseus Alloy Wheels (Silver Bright) – 245/40 R18 Y Tyres (Not 2.5FT)	£553.19	£96.81	£650.00	o	o	n/a	nco
18" Venator Alloy Wheels (Chromed) – 245/40 R18 Y Tyres (Not 2.5FT)	£1,310.64	£229.36	£1,540.00	o	o	n/a	u (£890)
18" Fortuna Alloy Wheels (Diamond Cut) – 245/40 R18 Y Tyres (Not 2.5FT)	£595.74	£104.26	£700.00	o	o	u (£50)	u (£50)
Tempa Spare Wheel	–	–	–	nco	nco	nco	nco
TPMS (Tyre Pressure Monitoring System)	£170.21	£29.79	£200.00	o	o	o	o
SST (Self Supporting Tyres) (Not V8 AWD) <sup>(ii)</sup>	£170.21	£29.79	£200.00	o	o	n/a	n/a
Rear Park Assist	£297.87	£52.13	£350.00	o	•	n/a	o
Front and Rear Park Assist	£553.19	£96.81	£650.00	o	u (£300)	•	o
Load Compensating Suspension	£425.53	£74.47	£500.00	o	o	o	n/a
Active Four-C Chassis (Continuously Controlled Chassis Concept) <sup>(iii)</sup>	£936.17	£163.83	£1,100.00	o	o	o	•

• = standard, o = option, n/a = not available, nco = no cost option, u (£) = upgrade.

(i) Cannot be ordered in conjunction with IR (Infrared) Reflective Glass and Graduated Tinted Windscreen.

(ii) Must be ordered in conjunction with 17" Canicula or 17" Spartes alloy wheels and TPMS (Tyre Pressure Monitoring System).

(iii) Cannot be combined with Load Compensating Suspension.

(iv) Heated Rear Seats must be combined with Heated Front Seats.

(v) Can only be combined with 2112, 2212, 2412 and 2412 upholsteries and is not available in combination with Walnut Wood Steering Wheel and Gear Knob.

(vi) Must be ordered in conjunction with Wood Trim.

(vii) Must be ordered in conjunction with Power Driver/Passenger Seats (SE models).

(viii) Dolby and Pro Logic Surround Sound™ are trademarks of Dolby Laboratories Licensing Corporation.

(ix) Must be ordered in conjunction with Rear Seat Entertainment.

(x) Volvo On Call includes Safety package (Security package available at additional cost). Must be ordered in conjunction with RTI Navigation System with RDS-TMC, Remote Control and Europe DVD Maps.

(xi) Cannot be ordered in conjunction with Dual Band Integrated GSM Telephone and Volvo On Call.

(xii) Must be ordered in conjunction with accessory Rubber Floor Mats and Luggage Compartment Mat. CZIP cannot be combined with Luxury Floor Mats, Winter Pack with Active Bending Headlamps and front and rear Ashtray with Cigarette Lighter.

(xiii) Cannot be ordered in conjunction with Bluetooth® Handsfree System.



OPTIONAL EQUIPMENT – INTERIOR	Basic £	VAT £	Rec Retail Price £	SE	SE LUX	EXECUTIVE	SE SPORT
Geartronic Transmission (Standard 3.2 and V8 Only) (not 2.0, 2.0D and 2.0F)	£1,191.49	£208.51	£1,400.00	o	o	•	o
Speed Dependent Steering System with 3 Settings (Standard SE Sport and V8 AWD only)	£191.49	£33.51	£225.00	o	o	o	•
Power Glass Tilt and Slide Sunroof	£723.40	£126.60	£850.00	o	o	o	o
Sun Curtain (Rear Shelf)	£85.11	£14.89	£100.00	o	o	o	o
Front and Rear Ashtray with Cigarette Lighter	–	–	–	nco	nco	nco	nco
Power Driver and Passenger Seats with Driver's Seat Memory	£510.64	£89.36	£600.00	o	•	•	•
Heated Front Seats	£191.49	£33.51	£225.00	o	•	•	•
Heated Rear Seats <sup>(iv)</sup>	£191.49	£33.51	£225.00	o	o	•	•
Anthracite Black Dash Top, Steering Wheel, Steering Column and Gear Knob <sup>(v)</sup>	–	–	–	nco	nco	n/a	nco
Walnut Wood Gear Knob Inserts (Geartronic Only) <sup>(vi)</sup>	£34.04	£5.96	£40.00	o	o	•	o
Cross Brushed Aluminium Trim	–	–	–	•	nco	n/a	•
Walnut Wood Trim	£212.77	£37.23	£250.00	o	•	•	o
Modern Wood	£212.77	£37.23	£250.00	o	nco	n/a	o
Walnut Wood Steering Wheel <sup>(vi)</sup>	£204.26	£35.74	£240.00	o	o	o	o
Leather-faced Upholstery	£1,021.28	£178.72	£1,200.00	o	•	n/a	n/a
Ventilated Leather-faced Upholstery <sup>(vii)</sup>	£1,276.60	£223.40	£1,500.00	o	u (£300)	n/a	•
Sovereign Hide Upholstery	£2,212.77	£387.23	£2,600.00	o	u (£1,400)	n/a	u (£1,100)
6 x CD Player	£212.77	£37.23	£250.00	o	o	•	o
Dynaudio Premium Sound Audio System – 1 x CD/Radio with Dolby Pro Logic II Surround Sound <sup>(viii)</sup> , 5 x 130W Amplifier, Aux Input (MP3/WMA Compatible) and 12 Dynaudio Speakers	£851.06	£148.94	£1,000.00	o	o	•	o
Rear Seat Entertainment with 1 x DVD Player in Front Centre Armrest, 2 x 8" screens, 2 x IR Headphones and Remote Control	£1,148.94	£201.06	£1,350.00	o	o	o	o
Rear Seat Audio Console with Headphone Sockets x 2	£80.85	£14.15	£95.00	o	o	•	o
Digital TV <sup>(ix)</sup>	£340.43	£59.57	£400.00	o	o	o	o
RTI Navigation System with RDS-TMC, Remote Control with Europe DVD Maps (2.0D only)	£1,574.47	£275.53	£1,850.00	o	o	n/a	o
Bluetooth® Handsfree System <sup>(x)</sup>	£212.77	£37.23	£250.00	o	o	o	o
Dual Band Integrated GSM Telephone with Handset	£425.53	£74.47	£500.00	o	o	o	o
Dual Band Integrated GSM Telephone with Handset and Volvo On Call <sup>(xi)(xiii)</sup>	£680.85	£119.15	£800.00	o	o	o	o
CZIP (Clean Zone Interior Package) <sup>(xii)</sup>	£102.13	£17.87	£120.00	o	o	o	o

	Basic £	VAT £	Rec Retail Price £	SE	SE LUX	EXECUTIVE	SE SPORT
<b>WINTER PACK</b>							
Heated Front Seats, Headlamp Cleaning System, Luxury Floor Mats and Heated Washer Nozzles	£382.98	£67.02	£450.00	o	n/a	n/a	n/a
Upgrade for SE Sport (if ordered with ventilated upholstery)	£234.04	£40.96	£275.00	n/a	n/a	n/a	o
Winter Pack with Active Bending Headlamps	£851.06	£148.94	£1,000.00	o	•	•	n/a
Upgrade for SE Sport (if ordered with ventilated upholstery)	£702.13	£122.87	£825.00	n/a	n/a	n/a	o
<b>COMMUNICATIONS PACK (2.0D only)</b>							
RTI Navigation System with RDS-TMC, Remote Control with Europe DVD Maps, PCC (Personal Car Communicator) with Heartbeat Sensor and Keyless Drive and Bluetooth® Handsfree System <sup>(x)</sup>	£1,702.13	£297.87	£2,000.00	o	o	n/a	o
Communications Pack (not 2.0D)	£468.09	£81.91	£550.00	o	o	n/a	o
<b>DRIVER SUPPORT PACK (not 2.0, 2.0D, 2.0F, 2.5T and 2.5FT)</b>							
BLIS (Blind Spot Information System), ACC (Adaptive Cruise Control) with Distance Alert and Collision Warning with Auto Brake and LDW (Lane Departure Warning) with DAC (Driver Alert Control) <sup>(i)</sup>	£1,276.60	£223.40	£1,500.00	o	o	o	o
<b>SECURITY PACK</b>							
PCC (Personal Car Communicator) with Heartbeat Sensor and Keyless Drive, Laminated Side Windows and Water Repellent Front Side Windows and TPMS (Tyre Pressure Monitoring System)	£638.30	£111.70	£750.00	o	o	n/a	o



## What's your style?

At Volvo we know everyone is different. And that's why you can choose from a whole spectrum of colours for the exterior of your Volvo S80. Whatever your style, you'll find the perfect shade for you.



019 Black Stone



426 Silver metallic<sup>(i)</sup>



452 Black Sapphire metallic<sup>(i)</sup>



453 Inscription™ White pearl<sup>(ii)</sup>



454 Ruby Red pearl



455 Titanium Grey pearl<sup>(i)</sup>



466 Barents Blue pearl



467 Magic Blue pearl<sup>(i)</sup>



472 Oyster Grey pearl<sup>(i)</sup>



473 Shimmer Gold pearl<sup>(i)</sup>



477 Inscription™ Electric Silver Coarse Flake metallic<sup>(i)</sup>



487 Inscription™ Ember Black pearl<sup>(i)</sup>



492 Savile Grey pearl<sup>(i)</sup>



493 Caper Green pearl



614 Ice White

NB It is not possible to reproduce exact original shades in printed matter. Please ask your Volvo dealer to show you samples. <sup>(i)</sup> S80 Executive only available with these colours. <sup>(ii)</sup> Exclusive to S80 Executive.

# The wheels

And now we come to one of the most important parts of choosing your new Volvo S80. Volvo alloy wheels come in a variety of different styles, cuts and finishes – each with its own distinct character.

Your selection of alloy wheel can dramatically influence the exterior styling of your Volvo S80. What will you choose?

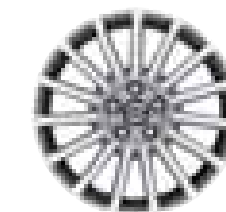

17" Regor

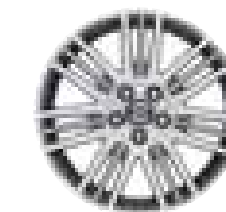

17" Meissa

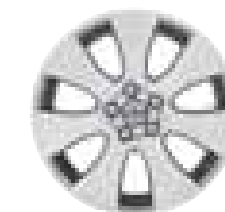

17" Spartes

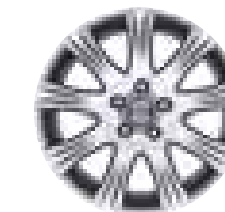

17" Cassini

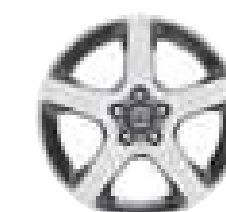

17" Canicula  
(Silver Bright)

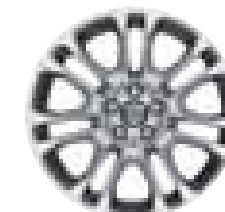

18" Zubra

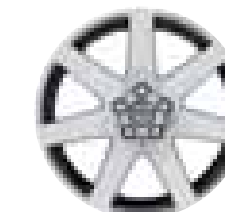

18" Venator  
(Chromed)

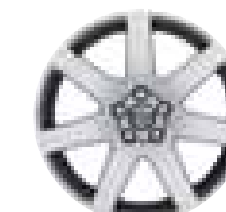

18" Venator  
(Silver Bright)

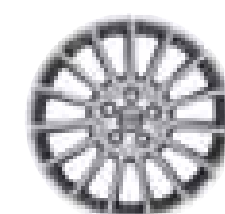

18" Balius

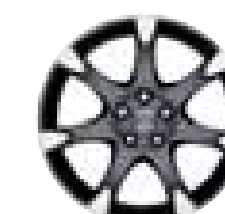

18" Fortuna  
(Diamond Cut)

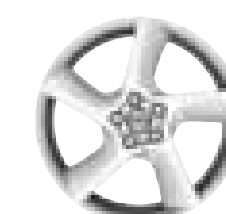

18" Odysseus  
(Silver Bright)





# Bespoke tailoring from Volvo

The finest fabrics, superb stitching and minute attention to detail – whichever interior you choose for your Volvo S80 you'll be surrounded by luxury. How will you tailor yours?

## SUNDBY TEXTILE/T-TEC



Off Black (2500)



Mocca Brown (2514)

## LEATHER-FACED



Off Black (2100)



Soft Beige with Off Black Panels (2102)



Soft Beige (2112)



Quartz Grey (2108)

## EXECUTIVE VENTILATED SOFT LEATHER



Off Black (2G00)



Soft Beige with Off Black Panels (2G02)



Soft Beige with Soft Beige Panels (2G12)

## VENTILATED LEATHER-FACED



Off Black (2200)



Soft Beige with Off Black Panels (2202)



Soft Beige (2212)



Quartz Grey (2208)

## SOVEREIGN HIDE



Off Black (2400)



Soft Beige with Off Black Panels (2402)



Soft Beige (2412)



Quartz Grey (2408)

NB For full colour breakdown of upholstery and interior, please refer to the upholstery section on the next page.

# Interior inlays

A selection of premium materials to complement your interior fabric.

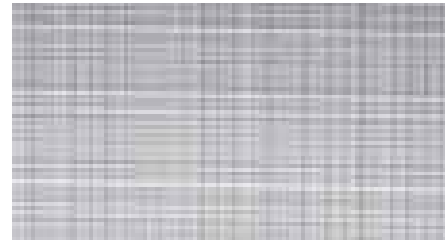

Cross Brushed Aluminium



Walnut Wood



Modern Wood



UPHOLSTERY	Upholstery Code	Interior Colour	Upholstery Colour	Dashboard Top	Door Panel, Lower Dashboard & Upper Tunnel Console	Carpet & Lower Tunnel Console	Door Insert Colour	Headliner Colour
Sundby Textile/ T-Tec	2500	Anthracite Black	Off Black	Off Black	Off Black	Off Black	Off Black	Soft Beige
	2514	Sandstone Beige	Mocca Brown	Espresso Brown	Soft Beige	Mocca Brown	Mocca Brown	Soft Beige
Leather-faced	2100	Anthracite Black	Off Black	Off Black	Off Black	Off Black	Off Black	Soft Beige
	2112	Sandstone Beige	Soft Beige	Espresso Brown	Soft Beige	Mocca Brown	Soft Beige	Soft Beige
	2102 2108	Anthracite Black Anthracite Black	Soft Beige Quartz Grey	Off Black Off Black	Off Black Off Black	Off Black Off Black	Soft Beige Quartz Grey	Soft Beige Quartz Grey
Ventilated Leather-faced	2200	Anthracite Black	Off Black	Off Black	Off Black	Off Black	Off Black	Soft Beige
	2212	Sandstone Beige	Soft Beige	Espresso Brown	Soft Beige	Mocca Brown	Soft Beige	Soft Beige
	2202	Anthracite Black	Soft Beige	Off Black	Off Black	Off Black	Soft Beige	Soft Beige
	2208	Anthracite Black	Quartz Grey	Off Black	Off Black	Off Black	Soft Beige Quartz Grey	Soft Beige Quartz Grey
Sovereign Hide	2400	Anthracite Black	Off Black	Off Black	Off Black	Off Black	Off Black	Soft Beige
	2412	Sandstone Beige	Soft Beige	Espresso Brown	Soft Beige	Mocca Brown	Soft Beige	Soft Beige
	2402	Anthracite Black	Soft Beige	Off Black	Off Black	Off Black	Soft Beige	Soft Beige
	2408	Anthracite Black	Quartz Grey	Off Black	Off Black	Off Black	Soft Beige Quartz Grey	Soft Beige Quartz Grey
Executive Ventilated Soft Leather	2G00	Anthracite Black	Off Black	Off Black	Off Black	Off Black	Off Black	Soft Beige
	2G02	Anthracite Black	Soft Beige	Off Black	Off Black	Off Black	Soft Beige	Soft Beige
	2G12	Sandstone Beige	Soft Beige	Espresso Brown	Soft Beige	Mocca Brown	Soft Beige	Soft Beige

NB It is not possible to reproduce exact original shades in printed matter.



# In fine detail

The nuts and bolts of your Volvo S80. Whatever you need to know about your new car – whether that's fuel consumption, CO2 emissions, top speed or boot space – you'll find it here.

ENGINE		2.0 Man	2.5T	3.2 Gt	V8 AWD Gt	2.0D Man	2.4D	D5	2.0F Flexifuel Man	2.5FT Flexifuel
Configuration		Transverse 16 valve	Transverse 20 valve	Transverse 24 valve	Transverse 32 valve	Transverse 16 valve	Transverse 20 valve	Transverse 20 valve	Transverse 16 valve	Transverse 20 valve
Cylinders		4	5	6	8	4	5	5	4	5
Engine capacity, cc		1999	2521	3192	4414	1997	2400	2400	1999	2521
Bore x stroke, mm		87.5 x 83.1	83 x 93.2	84 x 96	94 x 79.5	85 x 88	81 x 93.1	81 x 93.1	87.5 x 83.1	83 x 93.2
Max. output ECE,	PS kW rpm	145 107 6000	200 147 4800	238 175 6200	315 232 5950	136 100 4000	163 120 4000	185 136 4000	145 107 6000	200 147 4800
Max. torque ECE,	Nm rpm	190 4500	300 1500-4500	320 3200	440 3950	320 2000	340 1750-2750	400 2000-2750	190 4500	300 1500-4500
Octane rating		95 RON <sup>(i)</sup> unleaded	95 RON <sup>(i)</sup> unleaded	95 RON <sup>(i)</sup> unleaded	95 RON <sup>(i)</sup> unleaded	Turbo Diesel	Turbo Diesel	Turbo Diesel	95 RON <sup>(i)</sup> unleaded/ bio-ethanol (E85)	95 RON <sup>(i)</sup> unleaded/ bio-ethanol (E85)
Fuel system		Multipoint fuel injection	Multipoint fuel injection	Port fuel injection	Port fuel injection	Common rail direct injection	Common rail direct injection	Common rail direct injection	Multipoint fuel injection	Multipoint fuel injection
Compression ratio		10.8:1	9.0:1	10.8:1	10.4:1	18.5:1	17.3:1	17.3:1	10.8:1	9.0:1

PERFORMANCE		2.0 Man	2.5T Man	2.5T Gt	3.2 Gt	V8 AWD Gt	2.0D Man	2.4D Man	2.4D Gt	D5 Man	D5 Gt	2.0F Flexifuel Man	2.5FT Flexifuel Man	2.5FT Flexifuel Gt
Top speed (mph)		127	146	143	149	155	124	130	130	143	140	127	130	130
Acceleration 0-60 mph (sec)		11.0	7.2	7.5	7.4	6.0	10.4	9.0	9.5	8.0	8.5	11.0	7.2	7.5
0-62 mph (0-100 kmh) (sec)		11.6	7.7	8.0	7.9	6.5	11.0	9.5	10.0	8.5	9.0	11.6	7.7	8.0
Drag co-efficient		0.29	0.29		0.29	0.29	0.29	0.29		0.29		0.29	0.29	

FUEL CONSUMPTION <sup>(ii)(iii)</sup>		2.0 Man	2.5T Man	2.5T Gt	3.2 Gt	V8 AWD Gt	2.0D Man	2.4D Man	2.4D Gt	D5 Man	D5 Gt	2.0F Flexifuel Man	2.5FT Flexifuel Man	2.5FT Flexifuel Gt
Urban	mpg (l/100 km)	24.8 (11.4)	20.8 (13.6)	18.6 (15.2)	18.1 (15.6)	15.7 (18.0)	37.2 (7.6)	34.4 (8.2)	28.5 (9.9)	34.4 (8.2)	28.5 (9.9)	24.8 (11.4)	21.4 (13.2)	18.8 (15.0)
Extra Urban	mpg (l/100 km)	43.5 (6.5)	41.5 (6.8)	38.7 (7.3)	39.2 (7.2)	34.0 (8.3)	60.1 (4.7)	53.3 (5.3)	47.9 (5.9)	53.3 (5.3)	47.9 (5.9)	43.5 (6.5)	41.5 (6.8)	38.7 (7.3)
Combined	mpg (l/100 km)	34.0 (8.3)	30.4 (9.3)	27.7 (10.2)	27.4 (10.3)	23.7 (11.9)	49.6 (5.7)	44.1 (6.4)	38.7 (7.3)	44.1 (6.4)	38.7 (7.3)	34.0 (8.3)	30.7 (9.2)	28.0 (10.1)
CO2 g/km		199	223	244	246	284	151	169	194	169	194	199	219	241
VED (Vehicle Excise Duty) Band		F	F	G	G	G	D	E	F	E	F	F	F	G

POWER STEERING SYSTEM		All models
(rack & pinion)	225 Tyres	11.2 (36.7)
	245 Tyres	12.2 (40.0)

LUGGAGE COMPARTMENT	
Volume, litres (cu.ft)	422 (14.9)

		2.0 Man	2.5T	3.2 Gt	V8 AWD Gt	2.0D Man	2.4D	D5	2.0F Flexifuel Man	2.5FT Flexifuel
Brakes	Disc diameter front, mm	16"	16"	16.5"	17.5"	16"	16"	16"	16"	16"
	Disc diameter rear, mm	300	300	316	336	300	300	300	300	300
Transmission	Man	5 speed	6 speed	–	–	6 speed	6 speed	6 speed	5 speed	6 speed
	Gt	–	6 speed	6 speed	6 speed	–	6 speed	6 speed	–	6 speed
Fuel tank volume	litres (gallons)	70 (18.5)	70 (18.5)	70 (18.5)	70 (18.5)	70 (18.5)	70 (18.5)	70 (18.5)	70 (18.5)	70 (18.5)

INSURANCE GROUPS		2.0 Man	2.5T	3.2 Gt	V8 AWD Gt	2.0D Man	2.4D	D5	2.0F Flexifuel Man	2.5FT Flexifuel
Volvo S80	SE	13E	16E	17E	18E	13E	15E	16E	13E	16E
	SE Sport	14E	16E	17E	18E	14E	15E	16E	14E	–
	SE Lux	14E	16E	17E	18E	14E	15E	16E	–	16E
	Executive	–	–	17E	18E	–	–	16E	–	–

E = Exceeds security requirements for model concerned and group rating has been reduced.

WEIGHTS		2.0 Man	2.5T Man	2.5T Gt	3.2 Gt	V8 AWD Gt	2.0D Man	2.4D Man	2.4D Gt	D5 Man	D5 Gt	2.0F Flexifuel Man	2.5FT Flexifuel Man	2.5FT Flexifuel Gt
Min. kerb weight, kg (actual kerb weight dependent on spec.)		1565	1642	1659	1695	1839	1646	1670	1696	1670	1696	1565	1642	1659
Max. possible towing weight braked, kg		1500	1800	1800	1800	2000	1500	1600	1800	1600	2000	1500	1600	1800
Max. towing weight unbraked approx, kg <sup>(iv)</sup>		750	750	750	750	750	750	750	750	750	750	750	750	750
Max towball weight, kg		75	75	75	75	90	75	75	75	75	90	75	75	75
Max. total weight, kg		2060	2150	2160	2150	2320	2150	2190	2200	2190	2200	2060	2150	2160
Max. roof load, kg		100	100	100	100	100	100	100	100	100	100	100	100	100
Max. payload, kg (dependent on spec.)		495	508	501	455	481	504	520	504	520	504	495	508	501

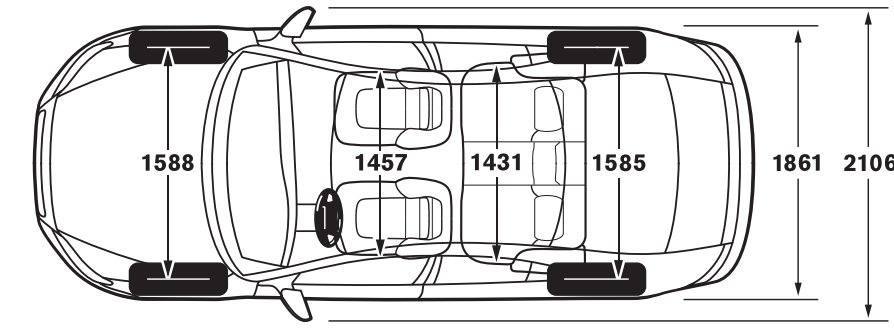
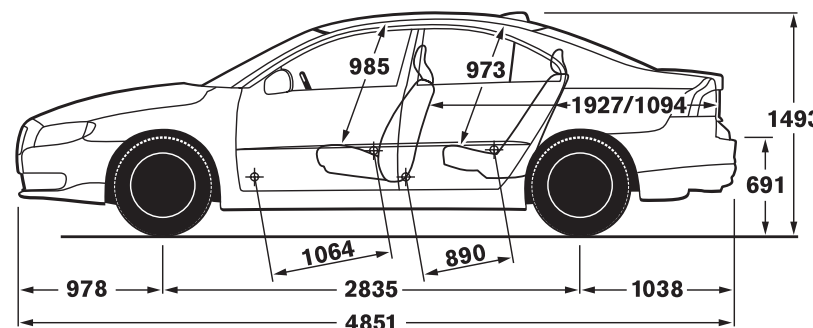

- (i) For best performance and lowest fuel consumption 98 RON is recommended. 95 RON can be used for normal driving.
- (ii) The results do not express or imply any guarantee of the fuel consumption of a particular car as there are inevitable differences between individual cars of the same model. Additionally, driving style, traffic conditions, as well as the age and mileage and standard of maintenance will affect a car's fuel consumption.
- (iii) The Urban fuel consumption figure is based on typical city driving, including starting the car from cold. The Extra Urban figure is based on typical motorway driving and cruising. The Combined figure averages the consumption across both cycles.
- (iv) Unbraked towing weight must not exceed 50% of kerb weight up to a maximum of 700 kg.

### Notes

The weight of the vehicle will influence the level of CO2 emitted. As a result, vehicles with higher levels of specification and factory fit options may emit higher levels of CO2. Once a vehicle has been built it will be given its own specific CO2 emission on which Vehicle Excise Duty will be charged.

A weighbridge must be used to determine specific weights.

Data valid for manual transmission unless specified.

Gt = Geartronic Automatic Transmission.

All measurements in mm.

The Max. output figures are quoted in PS (Pferdestärke), which is the metric equivalent of brake horsepower.

NB Some of the information in this price list may not be correct due to product changes which may have occurred since it was printed. Some of the equipment described or shown may now be available only at extra cost. Before ordering, please ask your Volvo dealer for the latest information. The manufacturer reserves the right to make changes at any time, without notice, to prices, colour, materials, specifications and models.

Volvo Car UK Limited, Globe Park, Marlow, Buckinghamshire, SL7 1YQ

# Accessories from Volvo

Of course, your Volvo S80 won't be perfect until it's exactly how you want it. And that's why we offer a range of accessories so you can completely personalise your new car. **The prices quoted below exclude fitting costs and are correct at time of going to press** – please confirm the total cost with your local Volvo dealer.

ACCESSORIES	Basic £	VAT £	Rec Retail Price £
<b>EXTERIOR ACCESSORIES</b>			
Aluminum Bike Rack (down tube clamp)	£53.13	£9.30	£62.43
Bike Rack (servo lift)	£84.12	£14.72	£98.84
Bike Rack (towbar mounted and collapsible)	£294.28	£51.50	£345.78
Bike Rack – extra bicycle towbar mounted	£69.20	£12.11	£81.31
Load Carrier – wing profile	£87.68	£15.34	£103.02
Mud Flaps (front)	£23.52	£4.12	£27.64
Mud Flaps (rear)	£27.42	£4.80	£32.21
Roofbox – Sport Time 200 (440 litre volume) <sup>(i)</sup>	£153.56	£26.87	£180.43
Ski/Snowboard Carrier with Sliding Rail	£58.87	£10.30	£69.18
Snow Chain – standard version (variety available) ...from	£256.90	£44.96	£301.86
Towbar – Detachable type with 13 Pin Electrics	£378.89	£66.31	£445.20
Rear Park Assist and Front Park Assist ...price for each from	£154.94	£27.11	£182.05
<b>INTERIOR ACCESSORIES</b>			
Garmin Portable Sat Nav	£310.64	£54.36	£365.00
Boot Mat – textile/rubber reversible	£88.58	£15.50	£104.08
Cooler/Hot Box (excludes power cable)	£70.85	£12.40	£83.25
Bluetooth® Hands-free Phone System ...from	£160.29	£28.05	£188.34
First Aid Kit	£17.88	£3.13	£21.01
iPod Interface	£238.30	£41.70	£280.00
USB Interface	£238.30	£41.70	£280.00
Combined USB/iPod Interface	£238.30	£41.70	£280.00
Rubber Floor Mats (set of four)	£42.09	£7.36	£49.45
Sunblind – rear door windows (pair)	£26.31	£4.60	£30.91
Sunblind – rear window	£26.31	£4.60	£30.91
Table (rear centre armrest)	£17.71	£3.10	£20.81
<b>CHILD SEATS</b>			
Child Seat ISOFIX <sup>(ii)</sup>	£127.40	£6.37	£133.77
Infant Seat ISOFIX <sup>(ii)</sup>	£89.92	£4.50	£94.42
ISOFIX base	£94.63	£16.56	£111.18
Baby Insert	£28.27	£4.95	£33.22
Child Booster Cushion	£30.69	£5.37	£36.06
Child Booster Backrest (to go with above)	£30.69	£5.37	£36.06
Padded Upholstery – for booster seat and headrest	£26.31	£4.60	£30.91

(i) Other roof boxes available – please ask your dealer for details.

(ii) VAT on Child Seats is 5%.

For further information and a complete list of all Volvo Accessories, take a look at the Accessory website at [www.volvocars.co.uk/accessories](http://www.volvocars.co.uk/accessories) or visit your local dealer.

## Try an S80 for yourself with Volvo Rental

Why not hire a Volvo S80 – or any other Volvo – from Volvo Rental? You'll be guaranteed to drive a Volvo prepared to the highest standards by your local Volvo dealer. Call 0800 400 430 for more information today.



# The end is just the beginning

It's a simple idea; one point of contact for all your car ownership needs – whether it's about finding the right finance deal or who to contact in an emergency. To get the most out of owning your Volvo, trust Care by Volvo.

### MAKING LIFE EASIER

Owning a Volvo should be a safe and enjoyable experience. To ensure it stays that way, we're committed to providing you with the best in support for as long as you own one.

### STARTING OFF ON THE RIGHT FOOT

You might be surprised how easy and flexible financing can be. Our range of finance, service and insurance options allows you to budget around one key factor – your lifestyle.

### FINANCE

As part of Volvo, Volvo Car Finance has developed a series of funding plans that will provide you with maximum choice and flexibility when acquiring a Volvo®. For details of the current promotions available, please visit [www.volvocars.co.uk/financepromotions](http://www.volvocars.co.uk/financepromotions)

### INSURANCE

Volvo Owners Insurance is designed for Volvo drivers and because we know Volvos inside out, we can offer exactly the right tools and expertise, fitting only genuine Volvo parts by trained Volvo technicians<sup>(ii)</sup>. Because Volvo drivers have an excellent reputation, we can also offer extensive cover at a reasonable price<sup>(iii)</sup>.

Call now for your insurance quote on **0800 238 239**, quoting reference BROCH.



**WHAT NEXT?** If you'd like to find out more about the range of products and services that make up Care by Volvo, the story continues at [www.volvocars.co.uk](http://www.volvocars.co.uk). Alternatively you can contact your nearest Volvo dealer or request relevant brochures.

(i) Finance subject to status. Guarantees/indemnities may be required. Volvo Car Finance SL7 1YQ.

(ii) When using a Volvo approved repairer.

(iii) Volvo Owners Insurance is underwritten by Royal & Sun Alliance Insurance plc (No. 93792). Registered in England and Wales at St Mark's Court, Chart Way, Horsham, West Sussex RH12 1XL. Authorised and regulated by the Financial Services Authority. For your protection telephone calls will be recorded and may be monitored. All benefits are subject to qualifying status, terms and conditions, cover level and underwriting criteria. Service and repair benefits are subject to being carried out by a recommended repairer.

### SERVICE PROGRAMME

Your Volvo dealer has the unique know-how to tailor a service programme according to Volvo's strict recommendations and guarantees you years of safety and driving pleasure.

### VOLVO ON CALL

Subscribe to Volvo On Call and you'll never be completely on your own. It's a GPS-based communication system providing 24-hour access to both emergency and roadside assistance wherever you are. See the Volvo On Call brochure for more information.

### LOOKING AHEAD

You'll probably never find out just how good some of these services are. But should the unexpected happen, we'd like to think that you'd be even happier you chose a Volvo.

### ROADSIDE ASSISTANCE

Every new car comes with one year's Volvo Assistance cover. You'll enjoy free breakdown and recovery assistance, anywhere in Europe, 24 hours a day. You can even extend cover for £85 for one year or £155 for two years. Call Volvo Assistance on **08701 650 978**.

### WARRANTY

Every new Volvo comes with comprehensive protection. Our warranty covers the first three years or 60,000 miles, whichever comes first. There's a three year unlimited mileage warranty on the paintwork, and either eight or twelve years against rust perforation. If a component fails due to a defect or material fault, your dealer will swiftly rectify the problem, free of charge.

# Volvo. for life

For tax free sales, including Military, Diplomat and all other Export enquiries, contact Volvo Car UK Tourist & Diplomat Sales or Volvo Car UK British Military Sales on **01707 262 388** or e-mail to [vcukics@volvocars.com](mailto:vcukics@volvocars.com) or [bms@volvocars.com](mailto:bms@volvocars.com)

All 'On The Road' prices quoted in this price list include Volvo standard national delivery charge, inclusive of number plates at £530 and the VED (Vehicle Excise Duty) car tax as of 1st September 2008. The 'On The Road' price also includes a £55 vehicle first registration fee (as set by the government – excludes Channel Islands and Isle of Man). Retail prices quoted do not include these additions.

**NB** Some of the information in this price list may not be correct due to product changes which may have occurred since it was printed. Before ordering, please ask your Volvo dealer for the latest information. The manufacturer reserves the right to make changes at any time, without notice, to prices, colour, materials, specifications and models.