



VOLVO S80



Volvo. for life A passion for safety  and the environment  – for well being inside and outside your Volvo.



In touch with the mood of the road—guided by dynamic intuition.

Imagine, just for a moment, a car that is blessed with power, control and an understanding of what goes on around it. The tensions of an unfamiliar route become smaller. The joys of an unexplored road become greater. And a perfect drive becomes a reality. The Volvo S80.



At ease in any situation, attentive to your every move.



The expressive stance and the graceful curve of the roofline accentuate the new Volvo S80's spirited elegance and head-turning good looks—whether you're pulling into a parking space or onto the open road.



Performance and intelligence in complete accord.



Volvo S80 V8 AWD (311 hp)

A highly refined and compact 4.4-liter engine that delivers up to 325 ft./lbs. of torque. Variable cam timing and the variable intake system contribute to exceptional fuel economy. And, thanks to innovative emission control technology, it complies with the toughest environmental demands, such as California's Ultra Low Emission Vehicle II (ULEV II).

Volvo S80 T6AWD (281 hp)

A new member of the Volvo range, this 3-liter engine offers smooth and fuel-efficient performance for the demands of everyday driving. But when the need arises (or if you're just in the mood), it provides an exhilarating thrust of turbo power that puts 281 hp and 295 ft./lbs. of torque at your disposal. ULEV II compliant.

Volvo S80 3.2 (235 hp)

An in-line six-cylinder engine. Also transversely mounted for generous deformation zones, this formidable power source delivers up to 236 ft./lbs. of torque. As well as variable cam timing and the variable intake system, the 3.2 employs Cam Profile Shifting to optimize performance and fuel economy. ULEV II compliant.

Power and control. How often do you find them in perfect harmony? The Volvo S80 offers fluid performance. Drivetrain and chassis perform as one. Acceleration is never delayed. Liveliness is assured by immediate response throughout the entire range of rpm. Modest fuel consumption is the product of low internal friction and advanced engine management. And of course, environmental demands are met—often with room to spare.



Intuitive technology at every turn.



The Volvo S80 has an uncanny feeling for your safety. Active Bi-Xenon headlights not only provide twice the illumination of conventional ones, they also pivot to help you see around curves. New features in the brake system help you bring things to a quick stop when the need arises while also providing an extra warning to fellow motorists. Dynamic Stability and Traction Control helps keep things on course. And the new adaptive cruise control makes highway driving a genuinely relaxing experience by not only helping to maintain a constant speed but also a set distance to the vehicle in front of you.

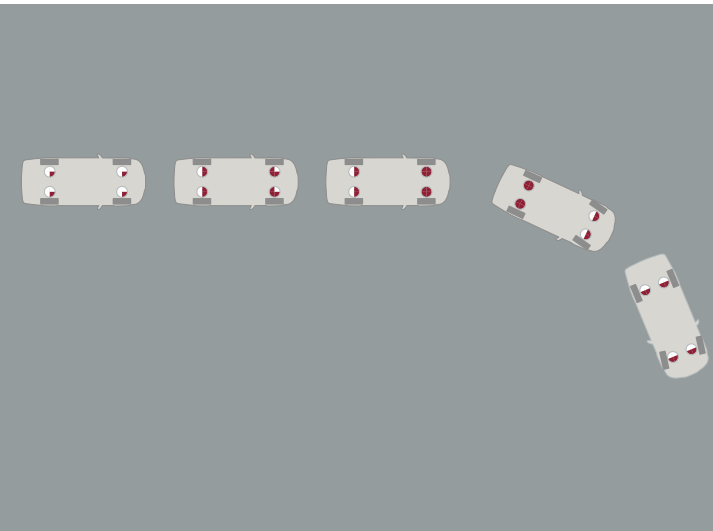
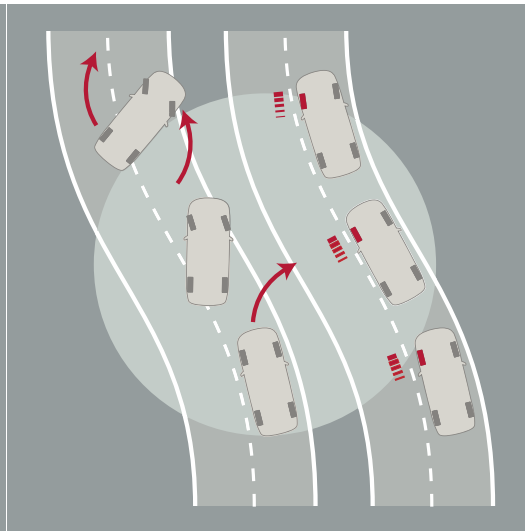
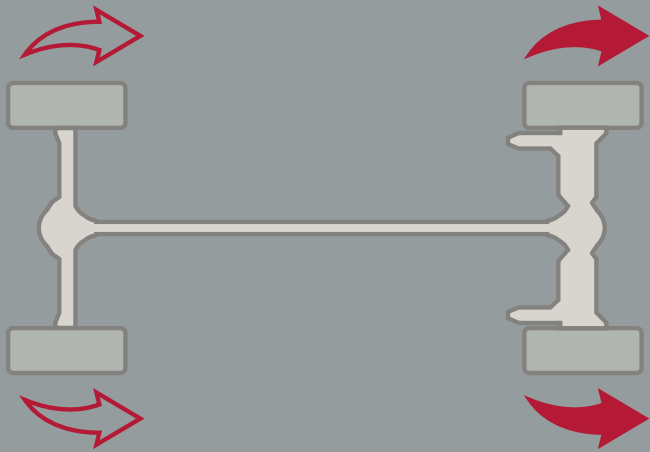

All-Wheel Drive with Instant Traction™

The AWD system (standard on the V8 and T6) is electronically controlled and has been developed with the high torque of the larger engines in mind. Constant hydraulic pressure ensures that power is promptly distributed among the wheels with the best grip. Wheel spin is minimized while acceleration and stability are enhanced, even in slippery conditions. When cruising on straight dry roads, the front wheels receive up to 95% of the power for efficiency. As conditions change, up to 50% of the power can be directed to the rear wheels. And when cornering, the system channels power back and forth to provide sharp turning and greater stability throughout the curve.

Transmission

All available engines are mated to a six-speed Geartronic transmission. Leave it in automatic mode for carefree driving, or nudge it into manual mode to shift gears yourself. The sixth gear is an overdrive, providing smooth and fuel efficient highway travel.



Dynamic Stability™ and Traction Control (DSTC)

Volvo's DSTC includes a number of functions that help enhance the safety and pleasure of driving. It improves traction in slippery situations by controlling the rotational speed of the drive wheels. By reducing the engine's power output or by braking one or more wheels, the system helps to counteract skids. It can also be set to allow a certain degree of wheel spin to provide better traction in snowy conditions.

Continuously Controlled Chassis Concept (Four-C)*

Further refined, Four-C now provides a choice of three distinctive driving modes—Comfort, Sport or Advanced. Whichever you choose, the system monitors the car, road and driver 500 times per second, simultaneously adjusting each shock absorber to maintain optimal handling. At the heart of the system is Volvo's semi-active suspension with continuously controlled Monroe-Öhlins shock absorbers. Furthermore, Four-C interacts with the DSTC system, engine, brakes and steering to support your chosen handling style.

*Optional

Inner comfort
is more than a sense of well being.



Volvo's designers feel they've created an environment ideal for driver and passenger alike. Floating layers, inspired by scandinavian landscapes, converge and soothe. Much attention has been paid to comfort throughout the cabin. Because you never know who might be traveling in it.



IAQS*

Interior Air Quality System monitors incoming air for certain unhealthy gases such as carbon monoxide and ground-level ozone. If necessary, it will temporarily close external air vents to shut them out. Meanwhile, an active charcoal filter prevents dust, exhaust particles, pollen and unpleasant odors from entering the car through the ventilation system.

*Optional

Ventilated front seats*

Ventilated front seats are available with a choice of three settings. The comfort setting maintains body temperature (approx. 98°F) by drawing air through the perforations in the leather and cushioning of the seat. Utilizing the car's air conditioning system, the cool air keeps the seat dry and comfortable in hot weather or on long trips. And when it's cold outside, the Volvo S80 front seat heaters provide three levels of warming comfort.

*Included in Sport Package

Ergonomics

Because no two bodies are identical, the driving position is highly adaptable. The seat itself offers a nearly limitless range of seating positions. And the adjustable steering column helps the driver to fine tune the ergonomics. The layout of instrumentation is pleasing and efficient.

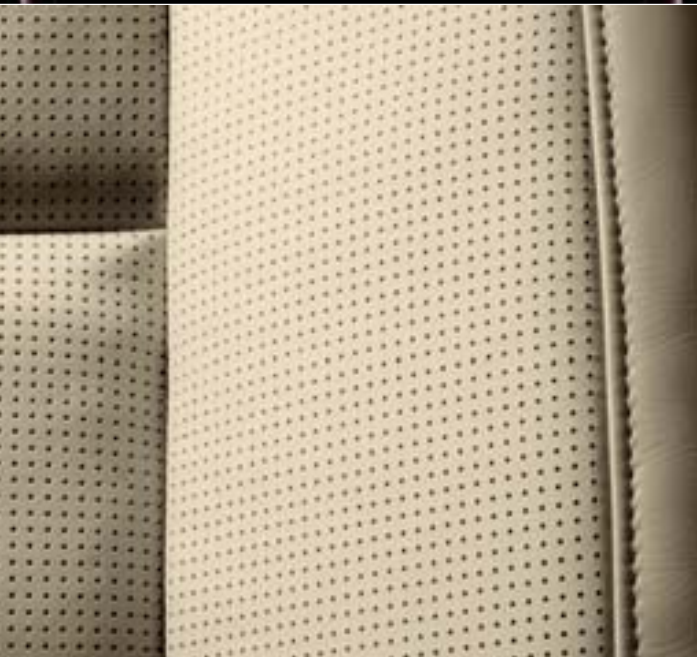



A seat belt reminder alerts the occupants of the front seats to fasten their seat belts. The power driver's seat includes a memory function to save seating and door mirror positions for up to three drivers. On V8 AWD models, the Power Parking Brake (PPB) is an electronic system that automatically releases the brake when the car starts to move.

Premium Sound. Playing at a theater near you.

This particular premium sound system is a landmark in automotive audio. The story begins a few decades ago when we started developing car audio and turned to some highly innovative partners. Driven by a group of passionate sound engineers, the collaboration that followed has flourished ever since. It led to the creation of Dolby Pro Logic surround (first used in a Volvo), and more recently to Dolby Pro Logic II, the theater technology that recreates sound so that everyone gets to enjoy it. From the class-d amplifier—a solution developed together with Alpine and Bang & Olufsen—the pleasure is then brought alive by Dynaudio, the danish speaker specialist that makes equipment for recording studios around the globe, and now for your Volvo S80.



The Premium Sound system's Dynaudio high-end speakers are powered by a 5x130 watts digital amplifier. These include three separate drivers—woofer, midrange and tweeter—in both front doors, and a similar set-up in the rear doors with separate woofer and tweeter. Each speaker has an independent crossover filter to harmonize with the others. To power them, the 5x130-watts digital class D amplifier features new technology enabling it to generate the most audio power from the least amount of current.

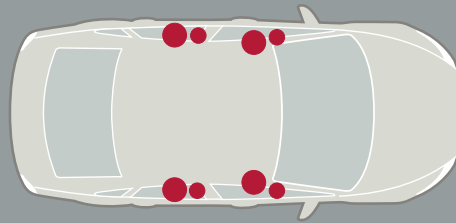

High Performance (standard)

A versatile sound system specially configured to the Volvo S80 interior. The High Performance amplifier, together with its high-end speakers, promotes excellent transient reproduction, high power durability and low distortion—in other words, superb sound. High Performance includes:

- RDS Radio
- 4x40 watts amplifier
- 8 High Performance speakers in-dash 6-CD
- MP3 and WMA compatible 6-CD player
- AUX input
- Steering wheel remote control

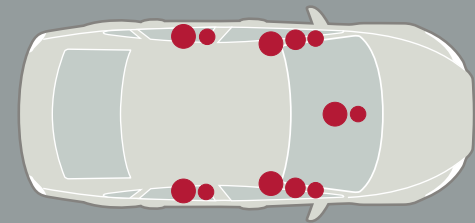

Dynaudio Sound System

The Dynaudio Sound System is in a class of its own. The class D digital amplifier generates 5x130 watts of music. Dolby® Pro Logic® II surround sound*, with its center speaker and sound processor, recreates a sound that's equally authentic in each seating position. There are 12 speakers developed by the Danish specialist, Dynaudio. Just for the Volvo S80. Dynaudio Sound System includes:

- RDS Radio
- 5x130 watts class D digital amplifier
- Dolby Pro Logic II surround sound
- 12 speakers by Dynaudio in-dash 6-CD
- MP3 and WMA compatible 6-CD player
- AUX input
- Steering wheel remote control

*Dolby, Pro Logic, and the double-D symbol are registered trademarks of Dolby Laboratories.



The Personal Car Communicator
—keeping you in touch with your Volvo.



Standard security features such as the sturdy door locks and electronic immobiliser help to prevent the tangible aspects of a break-in. The Personal Car Communicator on the other hand, offers you the comfort of knowing the car's status when you left it—even when you can't see it.



Personal Car Communicator (PCC)*

The PCC is an advanced remote control that combines keyless drive with two-way communication with your Volvo S80. Keep the PCC with you and the car unlocks automatically on your arrival. Start the engine by pressing a button on the dash, lock the car by pressing a button in the door handle. Later in the day, if you're wondering whether you've locked the car, the PCC can remind you; no matter where you are. On your return to the Volvo S80—within a radius up to 330 ft.—pressing the PCC information button will give you a current report on its status. And if the alarm has been activated, the onboard heartbeat sensor will give you advanced warning if there's somebody in your car and an opportunity to evaluate the situation safely.

*Optional

Keyless drive*

Keyless drive lets you lock, unlock and start the car without having the key in your hand. As long as you have the Personal Car Communicator (PCC) with you, pulling the door handle automatically unlocks the door. With your foot on the brake pedal, the press of a button on the instrument panel starts the engine. To lock the car, press a button in the door handle or lock it with the PCC.

Remote controlled alarm

Connected to the doors, hood, trunk and ignition, the alarm also reacts to the breaking of a window. A level sensor can be added to deter thieves from jacking-up the car and stealing your wheels. And in an emergency situation, the further option of a panic button on the remote control or on the PCC allows you to sound the alarm for help.

Approach and Home Safe lighting

Activated with the remote control or with the PCC, Approach Safe lighting provides a warm reception on a dark night. This consists of interior and side lights—ground lighting too, if you choose it. Home lighting is activated with the headlight stalk as you leave the car, and provides a similar courtesy. This one includes low beam headlights to accompany you to your door.

Ground lighting

Integrated in the door mirror, ground lighting is activated with the remote control or with the PCC. Beyond enhancing security to and from your car at night, it's also convenient when getting in and out.

⊕ This is where life starts.



“Safety is our promise. People trust us, and that’s a big responsibility. This is what we think about daily when we make our safety decisions. We have to maintain this trust—not only with words, but with actions. That’s also why the safety in a Volvo always begins and ends in a real life situation.”

Ingrid Skogsmo, Director Volvo Car Safety Center

Inaugurated in 2000, the Volvo Car Safety Center in Göteborg is the world’s most advanced crash laboratory. All with the purpose to imitate traffic situations and crashes as they happen in real life. Here we recreate crashes with all kinds of vehicles and road obstacles at any angle from 0 to 90 degrees and speeds up to 75 mph. We perform realistic roll-over tests and test cars in terrain as well as against genuine Swedish granite rock-face—we can even simulate impacts with

wild animals such as a 1100 lbs Swedish moose. Of course, these crash tests also incorporate advanced crash test dummies representing a wide range of sizes and ages—from infants to full-grown adults. Every crash is thoroughly documented using high-speed cameras and analyzed into fragments of thousands of seconds. We even store crashed cars for a period for future reference. Beyond countless computer simulations, we conduct over 400

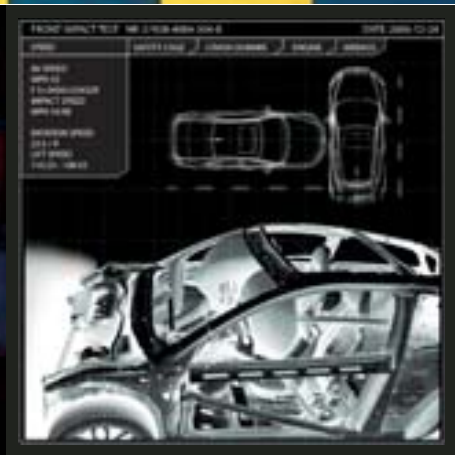

full-scale crash tests each year. These tests are based on what our Accident Research Team discovers on the road. Since 1970, our researchers have investigated over 36,000 real-life accidents. This gives us unique opportunities to learn what works in real life and what doesn't—knowledge that actually helps save lives.

Life-saving knowledge

Many of the safety features found in a Volvo are based on the findings from the Volvo Accident Research Team. A few recent examples are the collapsible steering column, the energy-absorbing frontal structure, Volvo's child safety equipment, the Side-Impact Protection System (SIPS) and the Whiplash Protection System (WHIPS).

Recreating reality into its smallest details

Advanced crash simulations are an important means of conducting realistic crash tests of separate components and interior safety systems. Our crash sleigh can recreate the exact movement the car makes the moment of collision, which is unique in the car world. This tipping affects the way occupants are restrained and is normally only possible to analyze through expensive full-scale crash tests.

Virtual crash tests

Super-computers make it possible for us to recreate and analyze different crash situations six times a day without crashing real cars. We have the technology to test new cars virtually even before they exist as prototypes, and we can incorporate extremely detailed virtual crash test dummies—we've even developed the world's first pregnant crash test dummy. This makes the full-scale testing very effective, and enables us to focus our resources where they are most useful.

⊕ This is living it.



Sweden. Other car manufacturers come here for final car testing under harsh and capricious conditions. For us it's home. This is where we live and drive, 365 days a year. So no wonder Volvos are in a category of their own when it comes to active safety. Take, for example, our own proving ground Hällered with its 34 miles of test tracks—including different road types from all over the world. This is the top secret facil-

ity where we scrutinize our cars' ability to support their driver in all imaginable (and unimaginable) situations. On tracks aimed to reveal any weak spots, we expose all new Volvo models to extreme forces and conditions during hundred thousands of miles. Not to mention the distances driven on ordinary Swedish roads. Here's where innovation confronts reality. Here's also where we evaluate the interaction between

the car and the driver. Because the most important safety feature in a Volvo is the driver. And the more efficiently the car's onboard systems support you as driver, the safer things are for you and your passengers

Double your illumination—twice

Designed in a country characterized by cold and darkness for several months a year, the headlights in a Volvo S80 combine separate reflectors to provide even and effective illumination in all conditions. And for even better night vision, there's the option of Bi-Xenon gas discharge lamps. Compared to conventional halogen headlights, Bi-Xenon headlights expand your vision range with about 230%. Driving at 60 mph, you'll be able to see 150 ft farther. Independent of the load, these headlights self-adjust to maintain the correct angle to the road—even during hard acceleration or braking.

NEW TECHNOLOGY FOR A NEW DRIVING EXPERIENCE.

Ultimately, no car is safer than its driver. So we loaded your Volvo S80 with state-of-the-art technology to support and help you make the right decisions. Inspired by technology normally found in fighter aircraft, systems like Volvo's Intelligent Driver Information System (IDIS) senses your workload and will withhold incoming phone calls and other peripheral information in stressful situations. And to further help assist you, there's the option of the radar based Adaptive Cruise Control with Collision Warning and Brake Support. Apart from enhancing driving comfort, this can be useful to help you maintain distance to the car in front of you. Collision Warning uses the same radar sensor to help you avoid or reduce the effect of a rear-end collision. Still, technology will never take the responsibility away from you as driver. The final decision is always in your hands. But if these technologies help make you more alert and relaxed as driver, they will also contribute to the overall safety and well being in your Volvo.

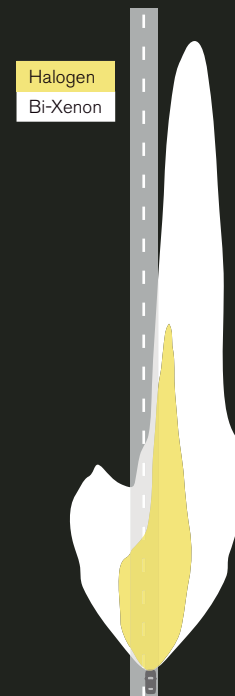

Emergency Brake Light (EBL)

Beyond the immediate response of the car's brake lights, EBL warns other road users about your emergency braking status. When the car's deceleration exceeds 0.7g, or when the anti-locking brakes are activated, an additional taillight on each side of the vehicle illuminates to help alert vehicles traveling behind you.

Hydraulic Brake Assist (HBA)

Helping the driver stop the car in the shortest possible distance, HBA employs a combination of vacuum and hydraulics. This ensures that the optimal braking power is always available when it's needed. Additionally, the hydraulic power maintains brake pressure even through prolonged brake usage.

Ready Alert Brakes (RAB)

Reducing the braking distance further, RAB uses information such as the sudden release of the accelerator or the Adaptive Cruise Control to anticipate an emergency braking. It moves the brake pads closer to the discs and pre-charges the brake system to help speed brake response.

Active Bi-Xenon Lights (ABL)*

Helping you to see around bends at night, this microprocessor controlled lighting system uses data such as steering wheel angle and car speed. The motorized lights turn up to 15° in either direction when driving—reliably lighting up your chosen path. A daylight sensor disengages the system during daytime to extend its lifespan.

*Optional

⊕ Designed for life.



IN A FRONTAL COLLISION the patented frontal structure with its sizeable deformation zones in different kinds of steel will yield to help absorb crash energy. In developing the Volvo S80's protective qualities, we have focused on frontal collisions at both higher speeds and with heavier vehicles. The compact power train is designed to help optimize deformation—all main components in the engine bay have their own predetermined positions to help keep components outside the cabin. A steel strut under the dashboard helps prevent components in the engine bay from intruding into the cabin. This also helps protect legs and feet.

The unique geometry of the frontal structure and longitudinal steel struts in the doors helps disperse crash energy away from the front to the rear of the car, further helping to reduce the strain on the occupants.

Inside the car, occupant protection is increased by optimizing the functions of all safety restraint systems. The seat belts with pre-tensioners on all seats and load limiters on the front seats interact with other safety features—such as the deformable steering column and dual-stage adaptive airbags—to help keep the occupants out of harm's way.

The interior is designed to help absorb as much crash energy as possible and to help reduce the risk of injury. For example, the ignition switch is positioned on the dashboard away from the driver's knees.



"To me, safety is beautiful. Every detail in a Volvo—from the interior ergonomics and the fantastic seats, to the body's powerful shoulders and softly rounded front—are there for safety reasons. This is functionality that goes hand in hand with distinctive design, and it sure looks good."

Steve Mattin, Design Director, Volvo Car Corporation

It is the interaction between the different safety systems that determines how safe a car is. Not the number of safety features itself. First, the driver must have the right conditions for well being behind the wheel. Seats, instruments, controls, visibility, lighting—all contributes to safety when they interact to support the driver. Then there's how the car behaves on the road. The way the chassis interacts with brakes, steering and

different stability enhancing systems not only determines how fun the car is to drive—this is also crucial to help the driver maintain control in challenging situations. Finally, if an accident can't be avoided, you and your passengers are surrounded by a wealth of interacting protective systems. Hopefully you'll never have to experience them in action. But it can be reassuring to know they're there to help protect you.

IN A ROLL-OVER the extremely sturdy safety cage will help protect the occupants while the seat belts help keep them restrained in their seats. If the car has initially been hit from the side, the Inflatable Curtain (IC) is activated to help protect the heads of the outboard occupants and help keep them inside the car. The IC remains inflated for several seconds to help provide extended protection, regardless of whether the windows are up or down. The energy absorbing interior also adds to occupant protection. Additionally, the roof structure is reinforced to help keep the passenger compartment intact.



IN A REAR IMPACT the rear deformation zones will help absorb as much as possible of the crash energy before it reaches the cabin. Similar to the front, the rear safety structure features an optimised mix of different grades of steel to provide strength and carefully controlled deformation. The fuel tank is designed to remain well protected in front of the rear axle. Even the exhaust system and spare wheel is designed to not affect the energy absorption.

Inside the cabin, the head restraints not only help protect the neck and spine, but also help protect the head from glass shatters. Integrated in the front seats, Volvo's unique Whiplash Protection System (WHIPS) cradles the spine and neck in a controlled manner. The system is activated by a collision of sufficient force from behind. Independent research has shown that WHIPS is one of the most effective in the world. Since its introduction in 1998, it has helped reduce long-term consequences by more than 50%.

IN A SIDE IMPACT the distance between your chest and the colliding car is about 1 ft. So how can we best use this distance to help protect life? To provide strength and carefully controlled deformation in a side impact, the door and side structure in the Volvo S80 is composed of a combination of ultra high strength steel and more pliant grades of steel. For example, the unique one-piece hydro-formed side structure is extremely strong to help withstand a severe side impact—even with a larger vehicle such as an SUV. And in the front seats, you'll find strong, rigid side-impact tubes. These transfer the loads from the side of the car into the center of the car, where a steel box is deformed. The dual-chamber side airbags in the front seats help protect the occupants chest and hip—the hip chamber inflates with five times higher pressure than the chest chamber to help absorb maximum impact where the body is most fragile. The Inflatable Curtain (IC) adds protection for the head and helps keep the occupants inside the car, both in the front and the rear.

 Environmental care.
Part of our commitment to
safety and your well being.



To choose a Volvo model on the basis of its overall environmental performance, see our Environmental Product Information (EPI) guide at www.volvocars.com/EPI



At Volvo, the well being of people is at the core of every decision we make. And just like safety, we believe that environmental care requires a holistic approach from the very start. For this reason, Volvos are built in some of the cleanest automotive plants in the world.

Air quality control

A cabin filter helps to prevent dust and pollen from entering the car through its ventilation system.

Testing materials for harmful substances

To make life more comfortable for people with allergies or asthma, upholsteries and interior textiles comply with the Oeko-Tex Standard 100—an international benchmark ensuring that textiles and leathers are tested for certain allergy inducing or harmful substances. All interior metal details are tested with regard to contact allergies—so parts such as keys, door handles and seat belt buckles comply with the same standards for nickel leakage as high quality jewelry.

Fuel efficiency

To increase fuel efficiency and reduce carbon dioxide emissions, all Volvo engines have advanced electronic management systems and low internal friction. Other factors that contribute to fuel economy include efficient transmission systems, aerodynamic body design, the use of various grades of steel to minimize body weight, and a trip computer displaying current and average fuel consumption.

Emission control

Volvo engines meet stringent international emission requirements. Advanced emission control technology eliminates between 95 and 99% of the carbon monoxide, hydrocarbons and nitrogen oxides in exhaust fumes. The emission control system is designed to provide full effect as rapidly as possible after a cold start—when emissions are at their highest. Right down to the fuel filler door, the fuel system is designed to reduce emissions through evaporation when the car is moving or at a standstill.

Clean all its life

Every Volvo begins its relationship with the environment at the earliest stage of its design. Volvos are built in some of the cleanest automotive plants in the world. What's more, our Environmental Product Information (EPI) allows you to choose a Volvo model on the basis of its overall environmental performance.





Factory-installed options.

The sense of quality and care—and knowing that you get the Volvo that suits your lifestyle. Customize your car with the options that best meet your demands and desires, and you'll soon be behind the wheel of your individually tailored Volvo S80.

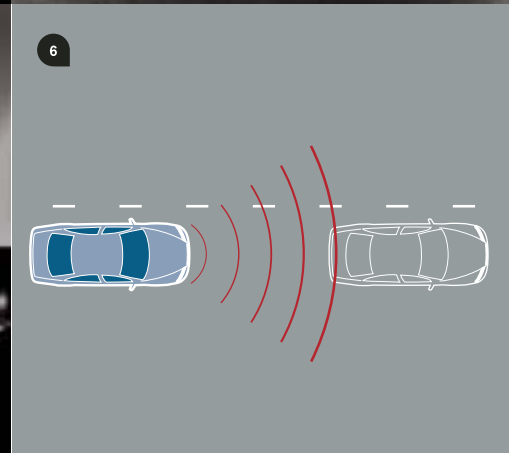

1

Personal Car Communicator (PCC)

PCC combines the ease of keyless drive with an interactive communication device that fits in the palm of your hand. In addition to making locking, unlocking and starting the car effortless, PCC provides a current report on the car's lock status. Press the information button to see if the car is locked or unlocked, if the alarm has been triggered, or with the optional heartbeat sensor, if someone is in the car.

2

Rear Seat Entertainment (RSE)

Opt for dual screen RSE and the rear-seat passengers can play a game or watch a film—separately or together. Thanks to separate wireless headphones, they can do their own thing while you listen to yours in the front. The system comprises two 7-inch wide screens integrated in the front seat head restraints and, at the back of the central armrest, a multifunctional DVD console with its own AUX socket.

3

Park Assist Front and Rear

This system makes it easier to park in tight spaces by providing an audible signal in the passenger compartment as a detected object gets closer to the sensors in the front or rear bumpers.

Also available as an Accessory.

4

Blind Spot Information System (BLIS)

The Blind Spot Information System uses digital cameras mounted in the door mirrors to keep a lookout on both sides of the car. As a vehicle enters your blind spot, the system alerts you with discreet lights built into both front door posts. Together with the door mirrors, this helps you change lanes safely. BLIS is activated once the car exceeds 6 mph, and reacts to almost any type of vehicle from a motorcycle upward. It works just as well day or night.

5

Volvo Navigation System (VNS)*

The Volvo Navigation System can guide you anywhere with precise audio and visual directions. A liquid crystal 6.5-inch display shows your location on a map and plots the best route. Controls are conveniently located on the steering wheel. All map-based information is stored on DVD.

*Maps do not cover all areas or all routes within an area. Also constant expansion and rebuilding of the road network mean that the digital map database is not always the latest road information. Always follow relevant regulations and road information.

6

Adaptive Cruise Control (ACC)

ACC is designed for highway use and includes a forward-scanning radar to monitor the time interval between your car and the vehicle in front. It also provides limited braking capacity. Simply set a cruising speed and a time interval and the system maintains it—slowing slightly to maintain distance to the car ahead when necessary.

Accessories.

Volvo's accessories help you make your Volvo S80 even better suited to your personal needs. They are the only ones that have been tested to meet Volvo's exacting safety, quality and environmental requirements. You can also rest assured they're a perfect match for the technology and design of your Volvo.



FOR DRIVING FREEDOM

- Fog Lights
- Moon roof wind deflector
- Park assist, front and rear
- Parking assistance camera
- Volvo Hands free with Bluetooth

FOR YOUR ENTERTAINMENT

- 6 Disc in dash CD changer
- Rear Seat Entertainment System with Dual DVD player
- Satellite Radio
- Volvo iPod Aux Adapter
- Volvo USB / iPod music player

FOR PRECIOUS CARGO

- Booster cushion and backrest
- Child Activity Bag
- Child Mirror
- Padded neck cushion
- Rear center armrest table
- Sun screen, rear doors
- Sun screen, rear window

FOR YOUR LEISURE

- Ashtray, front and rear
- Bike carrier, roof mounted
- Business bag organizer
- Canoe/Kayak carrier, roof mounted
- Cargo box, roof mounted
- Dirt cover, rear bumper
- Floor mats, rubber

- Grocery bag holders
- Integrated cooler / hotbox
- Load basket, roof mounted
- Luggage compartment mats
- Net pocket, side panel cargo compartment
- Portable Electric cooler / hotbox
- Roof Mounted "Load Bar" carrying system
- Roof ribs
- Ski Carriers, roof mounted
- Snowboard carrier, roof mounted
- Sun Glasses holder
- Surfboard carrier, roof mounted
- Trailer hitch mounted bike carrier
- Trailer hitch mounted load basket
- Trailer hitch mounted ski carrier

- Trailer hitch step
- Trailer Hitch, 2" Square profile
- Trailer mirrors
- Tunnel mat, second row seats

FOR YOUR LOOKS

- Aluminum Wheels
- Chrome Wheels
- Exterior Chrome Kit
- Footboard, moldings, illuminated
- Interior décor panel kits
- License plate frames
- Locking Lug nuts
- Valve stem caps
- Wood steering wheel

FOR UNEXPECTED SITUATIONS

- Car cover
- Electric engine heater
- First aid kit
- Jumper cables
- Leather care kit
- Mud Flaps, front and rear
- Snow chains
- Snow chains
- Warning triangle

See the 2008 Volvo Accessories brochure for a complete list of Genuine Volvo Accessories.

Interior selection.



Anthracite Black interior with Perforated leather Offblack upholstery (2200), Modern wood center console and door panel inlays, Charcoal leather-clad steering wheel and leather gear knob..

INTERIOR DESIGN. ANTHRACITE BLACK

The black on black combination makes a bold and beautiful interior and accentuates the wood trim and aluminum details. The front center armrest and interior door panels are color coordinated with the seats and upholstered in matching material



Modern wood trim
(3.2 and T6 AWD)



Anthracite Black interior,
Perforated leather Offblack upholstery (2200)
(Sport Package)



Anthracite Black interior,
Leather Offblack upholstery (2100)
(3.2 and T6 AWD)



Anthracite Black interior, soft leather
Sovereign Hide Offblack upholstery (2400)
(V8 AWD)

The Volvo S80 offers exclusive interior options to suit your personality. All our leather upholsteries are approved by Oeko-Tex. This means they're tested for certain allergy-inducing and harmful substances. Make your choices to compose your own interior styling.

INTERIOR DESIGN. SANDSTONE BEIGE

Start creating your Sandstone Beige interior here. The top of the dashboard is Espresso, and other interior sections are in Sandstone Beige. The front center armrest and interior door panels are color coordinated with the seats and upholstered in matching material.



Classic wood trim
(V8 AWD)



Sandstone Beige interior with Perforated leather Sandstone Beige upholstery (2212), Modern wood center console and door panel inlays, Sandstone Beige leather-clad steering wheel and leather gear knob.



Sandstone Beige interior, soft leather
Sovereign Hide Soft Beige upholstery (2412)
(V8 AWD)



Sandstone Beige interior,
Leather Sandstone Beige upholstery (2112)
(3.2 and T6 AWD)



Sandstone Beige interior,
Perforated leather Sandstone Beige upholstery (2212)
(Sport Package)



Exterior design.



The exterior design of the Volvo S80 projects its purpose; moving forward in space and time. Its evolution is indicated by body shape, and emphasized with converging lines. It's an unfinished sculpture—until you climb inside. **Stefan Jansson, Volvo design group.**



Venator 8x18"
Chromed
(optional)



Zubra 8x18"
Silver Bright
(incl. Sport package)



Meissa 8x17"
Silver Bright
(std. V8)



Regor 7x17"
Silver Bright
(std. 3.2)



Canicula 7x17"
Silver Bright
(std. T6 AWD)



Canicula 7x17"
Polished
(opt. Sport package 3.2 and T6)

Standard features.

SAFETY	S80 V8 AWD	S80 T6 AWD	S80 3.2
ABS - Antilock Brake System	●	●	●
Alarm	●	●	●
Approach Light	●	●	●
Center armrest with cupholder	●	●	●
DSTC Dynamic Stability Traction Control	●	●	●
Electronic Climate Control (ECC)	●	●	●
Emergency Brake Assist (EBA)	●	●	●
Heated windscreen washer nozzles	●	●	●
Home safe lightning	●	●	●
Homelink	●	●	●
Inflatable curtains	●	●	●
Isofix-outer position rear seat	●	●	●
Key Integrated Remote control, central locking (KIR)	●	●	●
Passenger airbag	●	●	●
Pyrotechnical pretensions, all seating positions	●	●	●
SIPS Curtain	●	●	●
Dual-chamber front SIPS bag	●	●	●
Whiplash protection, front seats	●	●	●
3 step airbag, drivers/passenger side with kneepad	●	●	●
INTERIOR			
Audio 'High Performance' 4x40 watts, 8 speakers	●	●	●
Audio control buttons in steering wheel	●	●	●
Auto Dimming inside rearview mirror with compass	●	●	●
AUX input	●	●	●
Classic wood	●	N/A	N/A

Factory options.

	S80 V8 AWD	S80 T6 AWD	S80 3.2
Adaptive Cruise control and brake system brake system with pre-charge	○	○	○
BLIS	○	○	○
Metallic Paint	○	○	○
Navigation system	○	○	○
Park assist front/rear	○	○	○
Personal Car Communicator (PCC)	○	○	○
Satellite Radio Prep - Sirius	○	○	○
Volvo Dual-screen Rear Seat Entertainment	○	○	○
8x18" Venator Chromed Alloy Wheels	○	○	○
17" Canicula Alloy w/Run-Flat Tire	N/A	○	○

● = Standard ○ = Option N/A = Not available

	S80 V8 AWD	S80 T6 AWD	S80 3.2
Cruise control	●	●	●
Electrical adjustable drivers seat, with memory	●	●	●
Electrical adjustable passengers seat	●	●	●
Front Armrest	●	●	●
Genuine Classic wood trim	●	N/A	N/A
Interior Air Quality System (IAQS)	●	○	○
Leather seating surfaces	●	●	●
Modern Wood	N/A	●	●
In-dash 6-CD with MP3 capability	●	●	●
Pollen filter	●	●	●
Power Glass Moonroof	●	●	●
Soft Leather Seating	●	N/A	N/A
Temperature gauge, outer	●	●	●
Watch dial instruments	●	N/A	N/A
2 illuminated sun visors	●	●	●
EXTERIOR			
Automatic 6-speed AWD	●	●	N/A
Automatic 6-speed FWD	N/A	N/A	●
Dual Exhaust	●	●	N/A
Foglight	●	●	●
Halogen lights	●	●	●
7x17" Canicula Alloy Wheels	N/A	●	N/A
7x17" Regor Alloy Wheels	N/A	N/A	●
8x17" Meissa Alloy Wheels	●	N/A	N/A

● = Standard ○ = Option P = Package N/A = Not available



Packages.

CLIMATE PACKAGE

In a Volvo you're always prepared to deal with the ever-changing forces of nature. And to increase comfort when driving in cold, rain or snow—simply add the Climate Package.

- Heated front seats
- Heated rear seats
- Heated windshield washer nozzles
- High-Pressure headlight cleaning
- Rain sensor windshield wipers

DYNAUDIO SOUND PACKAGE

This is a package that perfectly augments the audio system, concert hall sound by letting you listen to your own favorite music or radio stations, while making it safer and more convenient to use your cell phone.

- Dolby® Pro Logic® II Surround sound
- Premium Sound system
- Rear seat Headphone jack and audio controls
- Sirius™ satellite radio
- 12 Dynaudio speakers
- 5 x 130 watts amplifier

SPORT PACKAGE*

Inspiring dynamics are always at hand, whenever you're in the mood. And with the Sport Package, you'll further enhance your driving experience.

- Active Bi-Xenon headlights
- Four-C chassis with three settings
- Speed-sensitive steering
- Ventilated front seats with unique perforated seating surfaces
- 8x18" Zuba alloy wheels with 245/40R18 performance tires**

*Requires Climate Package.

**Can be exchanged for 17" polished Canicula wheels with all-season tires on 3.2 and T6

Volvo S80 specifications.

ENGINE

Eight-cylinder engine

Eight-cylinder 4.4-liter all-aluminum engine. 60-degree v-configuration. Double overhead camshafts, 32 valves. Variable Valve Timing (VCT) and Variable Intake System (VIS). Electronic engine management system. Three-way catalytic converter with a heated oxygen sensor. Allied with an advanced all-wheel drive system and a six-speed Geartronic transmission, this highly compact V8 harmonizes perfectly with the agile character of the Volvo S80. The sophisticated engine design, boasting continuously variable valve timing and a variable intake system, promotes high performance, smooth running, and superior power from low rpms. The full torque potential of 325 ft./lbs. is delivered at 3950 rpm, while at only 2000 rpm the engine delivers 236 ft./lbs. From a standstill, 60 mph is only 6.0 seconds away—there's ample power for passing other vehicles quickly and safely, as well as for long and comfortable trips. Advanced emission controls, featuring four catalytic converters, reduce harmful emissions beyond the standards required by current legislation, such as California's strict ULEV II, making this V8 one of the cleanest in its class.

Volvo S80 V8 AWD (311 hp)

Engine type: 4.4-liter V8 engine
Max power output: 311 hp at 5950 rpm
Max torque: 325 ft./lbs. at 3950 rpm
Acceleration 0–60 mph: 6.0 sec
Top speed: 130 mph
Fuel consumption, mpg, mixed cycle: N/A
Environmental classification: ULEV II
Transmission: Six-speed Geartronic automatic

Six-cylinder engine

Six-cylinder in-line 3.2-liter all-aluminum engine. Double overhead cam-shafts, 24 valves. Variable Valve Timing (VCT), Variable Intake System (VIS) and Cam Profile Shifting (CPS) on the intake camshaft. Electronic engine management system. Three-way catalytic converter with a heated oxygen sensor. This highly compact in-line six-cylinder engine meets high expectations in terms of performance, comfort and concern for the environment. The smooth running and responsive engine character provides a relaxed drive at all speeds. Advanced engine technology, such as a new intake system, helps increase torque over a wide speed range and ensures power at high rpms. And depending on your driving style and the situation, the intake valve train automatically switches between economy and performance modes to optimize efficiency. The engine's compact design aids safety performance in a frontal collision. The latest generation of fast response emission control technology

ensures that the engine complies with stringent environmental standards such as California's ULEV II.

Volvo S80 T6 AWD (281 hp)

Engine type: 3.0-litre in-line six-cylinder engine with Twin-scroll turbo
Max power output: 281 hp at 5600 rpm
Max torque: 295 ft./lbs at 1500-4800 rpm
Acceleration 0–60 mph: 6.5 sec
Top speed, auto: 130 mph
Fuel consumption, mpg, mixed cycle: N/A
Environmental classification: ULEV II
Transmission: Six-speed Geartronic automatic

Volvo S80 3.2 (235 hp)

Engine type: 3.2-liter in-line six-cylinder engine
Max power output: 235 hp at 6200 rpm
Max torque: 236 ft./lbs. at 3200 rpm
Acceleration 0–60 mph: 7.4 sec
Top speed: 130 mph
Fuel consumption, mpg, mixed cycle: N/A
Environmental classification: ULEV II
Transmission: Six-speed Geartronic automatic

DRIVELINE

Front wheel drive (V8 AWD and T6 AWD features an electronically controlled all-wheel drive system). Transverse engine. Six-speed Geartronic automatic is standard. Geartronic—a responsive six-speed automatic for relaxed driving that also allows manual gear shifting so that you can maintain a lower gear to bring up the rpms, or provide the added assistance of engine braking.

CHASSIS

Front suspension with spring struts (McPherson), anti-dive and anti-lift function. Active multi-link independent rear suspension. Stabilizer bars front and rear. DSTC (Dynamic Stability and Traction Control). The rigid body enables optimal suspension performance, balanced handling and a high level of comfort. Front and rear suspension interact to provide stable braking and smooth steering. In a curve, the rear wheels have a slight steering facility for added stability and steering response. The DSTC system engages if either of the drive wheels begins to lose traction or if a skid is imminent.

STEERING

Power-assisted hydraulic rack and pinion steering. Tilt and telescopic steering wheel column. 2.8 turns lock to lock. Turning circle 36.7 ft. (depending on tires).

Steering is responsive yet firm. The optional speed dependent power steering gives progressively less power assistance the faster you drive. Higher steering precision and enhanced road feedback are further benefits. At lower speeds, added power assistance makes the car even easier to maneuver, for instance when parking. Three different steering force levels can be selected in the car's information menu to suit different drivers and driving conditions.

BRAKES

Power-assisted anti-locking disc brakes (ABS), ventilated discs front. OHB (Optimized Hydraulic Brakes). HBA (Hydraulic Brake Assist). RAB (Ready Alert Brakes). FBS (Fading Brake Support). EBD (Electronic Brake Distribution) between the front and rear brakes. Diagonally split braking system. Generously dimensioned anti-locking disc brakes and optimized hydraulics help to ensure a short stopping distance in all situations. Furthermore, they withstand tough use without fading. HBA helps you use your brakes to the full in an emergency situation, while RAB anticipates severe braking and prepares for it by moving the brake pads closer to the discs. FBS automatically compensates for the higher pedal forces required after long periods of heavy braking. EBD distributes the braking effect between the front and rear wheels to achieve optimal results according to load and driving conditions.

FUEL TANK

18.5 US Gallons

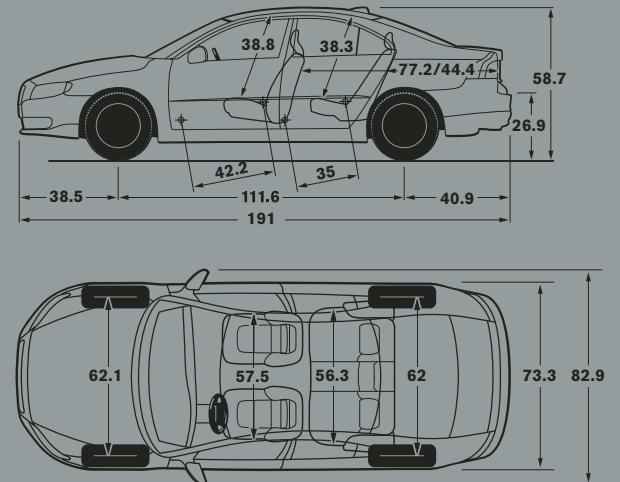

Meet the family.

To live life is to care about it.

S



The new Volvo S40 The compact and energetic sedan.



Volvo S60 The sports sedan worth getting passionate about.



Volvo S80 The premier sedan, meticulously engineered for superior driving comfort.

V



The new Volvo V50 The Sportswagon—flexible, compact and full of zest.



The all-new Volvo V70 The genuine family wagon—highly competitive yet comfortably versatile.

XC



The all-new Volvo XC70 The rugged yet stylish all-roader.



Volvo XC90 The versatile SUV that takes you anywhere with grace.

C



The new Volvo C30 The compact and charismatic SportsCoupe.



Volvo C70 A convertible when you want it.



Volvo C70 A coupe when you need it to be.

Every moment in a Volvo is a moment designed to celebrate life. A life full of twists and turns, ups and downs; the little things as well as the big ones. Of course, to live life to its fullest isn't just about you caring for others is important as well.

For almost eighty years we have helped save lives on roads around the world. Nevertheless, when it comes to improving automotive safety, we will never be satisfied. And while we're seeking new solutions, our existing safety systems are preventing many accidents from happening and providing some real protection when they do.

Our passion for life means looking after our children's children, too. Which is why we try to balance the needs of our company with those of society. With this bigger picture in mind, we develop engines and technology that have less impact on mother earth. This approach also explains why we pay so much attention to your immediate environment—in the car. Simply put, we care about you—and the whole circle of life.

Taking care of your ownership needs.

It's a simple idea; one point of contact for all your car ownership needs, whether it's finding the right financing or who to contact in an emergency.

Get the most out of owning your Volvo.

Volvo Car Finance North America

If you purchase or lease your Volvo through Volvo Car Finance North America, you can take advantage of services designed to make financing simple and convenient. Quick Debit, for instance, enables you to have your monthly payment automatically debited from a designated bank account. For more information, call 1-800-770-8234 or visit www.volvofinance.com

On Call roadside assistance

Whenever you need us, we're just a phone call away. Our nationwide network of retailers and authorized service providers are ready to assist. Whether you require roadside assistance or maps and routing information for your next trip, refer to your On Call Card and dial 1-800-63-VOLVO—anytime, day or night. Your complimentary four-year membership activates the moment you become a Volvo owner.

Volvo new car warranty

Your new car warranty provides comprehensive coverage for four years or 50,000 miles, whichever occurs first. Additional warranties cover corrosion, seat belts, the supplemental restraint system, emission systems, genuine Volvo replacement parts and genuine Volvo accessories. Should you encounter any problem with your Volvo, simply contact the nearest retailer for assistance. Where your warranty ends, Volvo Increased Protection (VIP) plans begin. To purchase the additional protection of a VIP plan, contact your local retailer.

Volvo genuine service

The best way to ensure superior performance year after year is to bring your Volvo to your authorized retailer for regular maintenance. Our service advisors and factory-trained technicians are uniquely qualified to maintain your automobile. With the aid of advanced Volvo diagnostics, they follow all prescribed factory maintenance outlined in your service interval manual. Genuine Volvo Service is our ongoing commitment to you: to keep your Volvo performing smoothly long after other cars have given up.

Volvo mobility program

The goal of the Volvo Mobility Program is to assist persons with physical disabilities or hearing impairment achieve independence. For those with exceptional transportation needs, freedom can be facilitated within the extraordinary comfort and safety of a specially adapted Volvo. For additional information on this program, please contact the Volvo Mobility Program Headquarters at (800) 803-5222 or visit www.volvocars.us/mobility. TTY users are invited to call 1-800-833-0312.

Personal shopper

The Volvo Personal Shopper is dedicated to providing you with a whole new level of shopping convenience. Whether you'd like help identifying the Volvo model that best fits your lifestyle, detailed information on any Volvo model, or a comparison against the competition, Volvo is there to help. We can arrange a Guest Drive for you at your nearest Volvo Retailer. So make the most of your shopping time and call the Volvo Personal Shopper at 1-800-550-5658. (U.S. only)

Volvo Overseas Delivery.

Volvo Overseas Delivery offers a unique way to buy your new custom-built car as well as a unique way to see more of Europe. And when you're done traveling, bring the pleasure of driving a Volvo back home. Purchase any new Volvo as part of the Volvo Overseas Delivery Program and enjoy all this—and more:

- Attractive pricing on US models.
- Two complimentary round-trip tickets with Scandinavian Airlines.
- One free hotel night in Gothenburg, Sweden, the home of Volvo.
- An exciting Volvo Factory Tour or a visit to the new Volvo Brand Experience Center.
- An exclusive VIP delivery experience at the Volvo Factory Delivery Center.
- The opportunity to explore Europe in the comfort and safety of your own Volvo, either with one of our spectacular tours or on your own.
- Extensive complimentary home shipment services. Just leave your car with us. We'll ship it to you the convenient way while you relax and enjoy your complimentary flight back home.

Can you think of a better way of traveling overseas and making your souvenir part of an unforgettable experience?

If you would like to know more, contact your local Volvo retailer, our Customer Care Center (800) 631-1667, or visit www.volvocars.us/mybagsarepacked

A world of colors.



614 Ice White



473 Shimmer Gold metallic*



471 Willow Green metallic*



426 Silver metallic*
(3.2 and T6 AWD)



472 Oyster Grey metallic*



019 Black Stone
(3.2 and T6 AWD)



453 White metallic*
(V8 AWD)



466 Barents Blue metallic*



487 Ember Black metallic*
(V8 AWD)



477 Electric Silver metallic*
(V8 AWD)



455 Titanium Grey metallic*
(3.2 and T6 AWD)

* Metallic paint is an option.

Please note: It is not possible to reproduce exact original shades in this brochure. Ask your Volvo retailer to show you samples.

As part of our commitment to the environment, the paper used in this brochure is recycled, and color choices were printed directly on the page. This eliminates the need for chemically treated color chips. A small thing perhaps, but then, every little bit helps.

Volvo. for life

VOLVO
Volvo Car Corporation

WWW.VOLVOCARS.US

Specifications, features, and equipment shown in this catalog are based upon the latest information available at the time of publication. Volvo Cars of North America, LLC reserves the right to make changes at any time, without notice, to colors, specifications, accessories, materials, and models. For additional information, please contact your authorized Volvo retailer.

© 2007 Volvo Cars of North America, LLC. Printed in USA on 100% recyclable paper. **MY08C**