



THE NEW VOLVO S40



From Sweden with love.



Volvo. for life A passion for safety  and the environment  – for well being inside and outside your Volvo.



Take a look at this refined compact sedan by Volvo. See the play between the straight and curved lines of the body (it is as much a treat for the air as it is for the eyes). Take another look and you'll experience esthetics that are more than skin deep. Because this Swedish beauty will always put you first. Rather than complicate, it will simplify and embrace any aspect of your life. And if you ever get into trouble, this partner will be there for your protection.

The new Volvo S40. Simply beautiful.



It's an affair of the heart.



Fuel efficiency

Advanced engine technology and aerodynamics offer the performance you expect and help keep down fuel consumption and carbon dioxide emissions—among the main contributors to global warming. Of course, all Volvo engines comply with stringent international environmental requirements.

Your heart will whisper that you need a sparkling engine which runs smoothly and has a low environmental impact. Your brain will check the performance, engine characteristics and fuel consumption (figures on page 34). When both agree, you've found the energy source for a long and rewarding relationship.



All-Wheel Drive (AWD)

The T5 AWD electronically controlled all-wheel drive system offers superb road holding on all surfaces. Power is channelled to the front and rear wheels according to the conditions. Normally the car is almost entirely front-wheel driven, for optimum stability and fuel economy. As the situation dictates, up to 50% of the power is instantly redirected to the rear wheels. And since the pair of wheels with the best grip always receives the most power, the car is exceptionally sure footed on slippery roads.

Manual transmission

The manual transmission offers fluid and precise gear shifting. A five-speed manual transmission is standard on 2.4i. The smooth action of the clutch assures that you move off with confidence and grace.

Geartronic automatic transmission

Geartronic is a five-speed automatic that's both smooth and responsive. It harmonizes perfectly with your Volvo and when you're in the mood for more activity, nudge the lever over to manual mode to shift up or down with a press of the gear lever. Geartronic is optional with the 2.4i and standard on T5 and T5 AWD.



Trip computer (optional)

Know the current and average fuel consumption, driving range on current fuel reserves and average speed. Menu selection and resetting computer settings controlled by using the turn indicator stalk.

Volvo Navigation System (VNS)* (optional)

Employ voice guidance and graphic navigation all the way to your chosen destination. Extremely fast and precise, this new generation VNS features a hard disc drive covering maps for major parts of the country. The system is fully integrated in your Volvo and is easily controlled from the steering wheel. You can choose between two operating modes—Easy and Advanced. And when VNS is not needed, the screen retracts into the dash.

*Maps do not cover all areas or all routes within an area. Also constant expansion and rebuilding of the road network mean that the digital map database is not always the latest road and traffic information. Always follow relevant regulations and road information.

No confusion.

At the center of this universe, there's you. Every control and instrument is designed to help you stay in command. You can operate all important driving functions with both hands on the wheel. The car can even sense your work load and withhold less important driving information in stressful situations. To personalize some of the on-board systems, there's a menu control in the center console. And because a relaxed driver is a safe driver, the seating comfort is in a class of its own—the result of over thirty years of ergonomic research and the multiple adjustment possibilities for the seat and steering wheel.

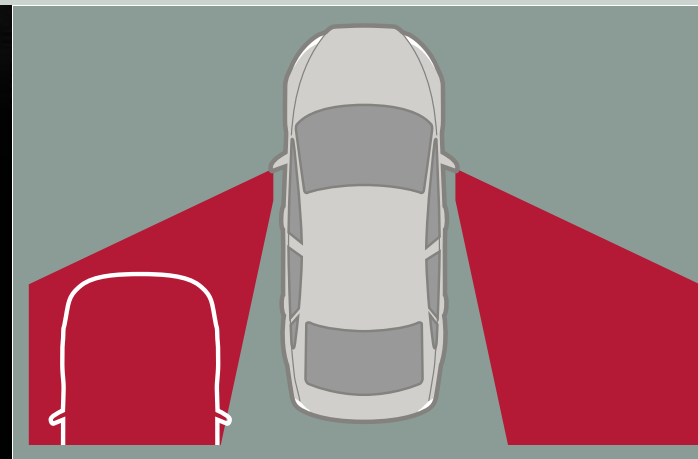

Intelligent Driver Information System (IDIS)

To avoid unnecessary distractions in critical driving situations, IDIS constantly analyses the driving situation. If necessary, it momentarily delays some information from the car's onboard systems. As soon as things calm down, the relevant warning is then relayed to the driver. Preferences can be made via the settings menu in the center console.

Keyless drive (optional)

Keep the car key in your pocket or handbag. Using the keyless drive system you can unlock the doors and drive away without using the car key. To start the engine, just twist the starter control in the instrument panel.

Blind Spot Information System (BLIS) (optional)

The next best thing to having eyes in the back of your head, BLIS is there to help when you're changing lanes. Rear-facing cameras in the door mirrors help detect vehicles moving into your blind spot and alert you of their presence. BLIS doesn't make any decisions for you, but it does help to keep you informed. BLIS is activated once the car exceeds 6 mph, and reacts to almost any type of vehicle from a motorcycle upwards. Day or night.





Here's where attraction turns to love.

Since you'll spend a lot of time here, we've spent a lot of time creating this relaxing interior. Its clean and simple lines are inspired by Scandinavian furniture design. The materials are pleasant to the touch, and you are surrounded by hundreds of considerate details. From the ergonomic seats and innovative storage, to the effective climate system and superior safety. It's just like home, so why not invite a friend (or four) for a ride?



Interacting safety systems

In this energy-absorbing interior all occupants are surrounded by world-class safety. Each seat is a safety zone in itself with multiple interacting protective features. This together with front airbags, front side airbags, inflatable curtains and three-point seat belts with pretensioners in all outboard positions help protect you and your passengers if necessary.

Clever design means clever amenities are just where you want them to be. Some of them you'll notice at once, others you will only fully appreciate after hours of driving. Like the innovative tunnel console with multi-functional front center armrest and cup holders under a roll-top cover. And take a look at the side of the front passenger's head restraint. There, you'll find a discreet hook to keep your jacket in convenient reach. Just details, but these often make a big difference in driving enjoyment.



Rear seat amenities

Rear seat passengers will appreciate the comfort of the folding armrest in the middle, not to mention the convenience of its integrated cup holders and storage trays that keep small items in place and at hand.



Front seat amenities

The new multifunctional armrest takes care of cups, CDs, coins, mobile phones, MP3 players and other vital goodies. There's even a table for rear seat passengers. In the tunnel console, integrated cup holders are hidden under a roll-top cover. Both front doors also feature generous storage, including a smart holder for the ice scraper.



Power windows

A quick press of the button in each door is all it takes to automatically raise or lower the windows. Alternatively, the windows can all be operated from the driver's seat and, if needed, the driver can override the controls for the rear windows.



Please resist your instinct to close your eyes.
(Unless you're occupying the passenger seat.)

A clean interior design is a treat in many ways that contributes to ideal acoustic conditions in your Volvo S40. What can be more natural here than a truly high-fidelity audio system like the new 650 W Premium Sound with Dynaudio with Dolby® Pro Logic® II surround sound and twelve state-of-the-art Dynaudio speakers. Just bring your iPod® or favorite CDs. Then experience music in the way in which it was originally intended to sound and feel.



MP3 compatibility

There are a number of ways to enjoy MP3 music files in your Volvo. If you'd like to connect your personal MP3 player to the audio system, there's a standard auxiliary audio input in the front center armrest. Volume is conveniently controlled from the steering wheel or center console. And by choosing the High Performance or Dynaudio Sound System, the CD player is playback compatible with both MP3 and WMA music files.

Dolby, Pro Logic, and the double-D symbol are registered trademarks of Dolby Laboratories.

iPod is a trademark of Apple Computer Inc.

6-CD changer

In place of the standard CD player, this CD-changer is integrated in the center console. It's conveniently controlled via the radio panel or the steering wheel keypad, and you can easily select one of up to six CDs while driving. MP3 and WMA music files are no problem at all.

140 W subwoofer*

If you like to feel the bass of your music through your body, the subwoofer with built-in 140 W amplifier provides superb reproduction of the deep register at all volumes. It's secured under the trunk floor, and can be switched off from the menu in the center console. Available with the High Performance audio system.

* Retailer Installed Accessory

Dynaudio speakers

The twelve Dynaudio high-end speakers of the Dynaudio Sound System are powered by a 5x130 W digital amplifier. There are three separate speakers—woofer, tweeter and midrange—in each front door, and in the rear doors there is a similar set-up with tweeter and woofer/midrange. Each speaker has a crossover filter to maximise fidelity. The latest generation Dolby® surround system with a center speaker and sound processor recreates authentic sound with a strong sense of presence for everyone in the car—a Volvo world first. The digital class D amplifier features a new technology to provide extremely high efficiency, enabling it to generate the most audio power from the least amount of current.

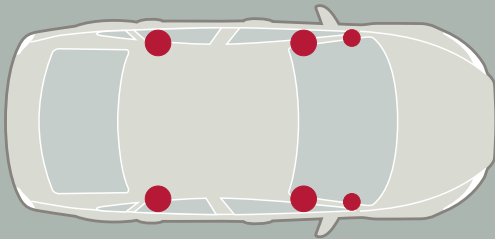

Performance (standard 2.4i)

A console-integrated radio and CD player. It sounds good, looks good and it's easy to use. Performance equipment includes:

- RDS radio
- CD player
- 6 loudspeakers
- 4x20 W amplifier
- AUX input

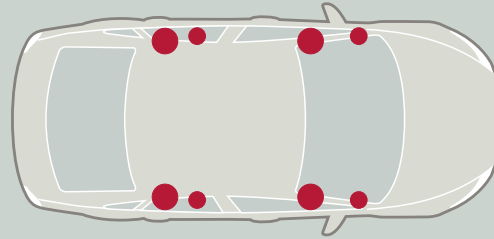

High Performance (standard T5, T5 AWD)

A powerfully versatile system. Each speaker is fitted with a more powerful magnet and a larger coil. In combination with the amplifier, this system promotes excellent transient reproduction and high power—quite simply superb sound. High Performance equipment includes:

- RDS Radio
- Sirius™ Satellite Radio
- Single CD player
- 8 High Performance speakers
- 4x40 W High Performance amplifier
- AUX input

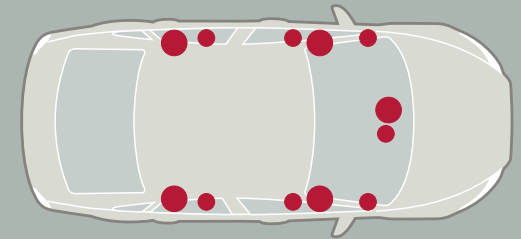

Dynaudio Sound System

Our new top-of-the line audio system designed for perfect sound dynamics, featuring 12 speakers by Danish specialist Dynaudio. With Dolby® Pro Logic® II surround sound for an authentic audio experience in all seats. Dynaudio Sound System equipment includes:

- RDS Radio
- Sirius™ Satellite Radio
- MP3 and WMA compatible 6-CD player
- 12 speakers by Dynaudio
- 5x130 W digital Class D amplifier
- Dolby® Pro Logic® II surround sound
- AUX input



Alarm

Connected to the doors, hood and trunk lid, the alarm even reacts to movement inside the car and the breaking of a window. Should you encounter an emergency situation on your way to or from the car, the alarm can be activated from your hand-held remote control.

Approach and Home Safe lighting

On your way to and from your car at night, Approach Light and Home Safe Lighting enable you to light up the car and its immediate environment.

Cherish what you hold dear.

Theft-protected door locks and electronic immobilizer make it almost impossible to steal your Volvo without the correct key. On your way to and from the car at night, you can light up the interior and the closest surroundings. With keyless drive you can step into your Volvo and drive away with the key still in your pocket.



Multifunction door mirrors

The generously dimensioned door mirrors are power operated using a joystick in the driver's door panel. Indicators are embedded in the sides of the mirror—a nudge of the indicator stalk will activate three flashes of the indicator light, so there's less risk your turn will go unannounced. To further enhance your safety and comfort, there are options such as puddle lights, Volvo's Blind Spot Information System (BLIS) and the ability to fold the mirrors electronically for those tight garage spots.



Remote controlled central locking

A touch of a button locks or unlocks the doors, trunk lid and can lower the windows. Use the personal settings menu to decide if the remote unlocks the driver's door first or all doors together. You can also unlock the trunk separately. All doors can be set to automatically lock the moment you drive away. Alternatively, lock them quickly using the button beside the interior door handle.



Keyless entry and keyless drive

The optional keyless entry and keyless drive provides extra security. You can unlock your car just by grasping the door handle, start the engine, and set the door locks again before you leave the car as long as you have your key in your pocket or handbag.

⊕ This is where life starts.



“Safety is our promise. People trust us, and that’s a big responsibility. This is what we think about daily when we make our safety decisions. We have to maintain this trust—not only with words, but with actions. That’s also why the safety in a Volvo always begins and ends in a real life situation.”

Ingrid Skogsmo, Director Volvo Car Safety Center

Inaugurated in 2000, the Volvo Car Safety Center in Göteborg is the world’s most advanced crash laboratory. All with the purpose to imitate traffic situations and crashes as they happen in real life. Here we recreate crashes with all kinds of vehicles and road obstacles at any angle from 0 to 90 degrees and speeds up to 75 mph. We perform realistic roll-over tests and test cars in terrain as well as against genuine Swedish granite rock-face—we can even simulate impacts with wild

animals such as a 1100 lbs Swedish moose. Of course, these crash tests also incorporate advanced crash test dummies representing a wide range of sizes and ages—from infants to full-grown adults.

Every crash is thoroughly documented using high-speed cameras and analyzed into fragments of thousands of seconds. We even store crashed cars for a period for future reference. Beyond countless computer simulations, we conduct over 400

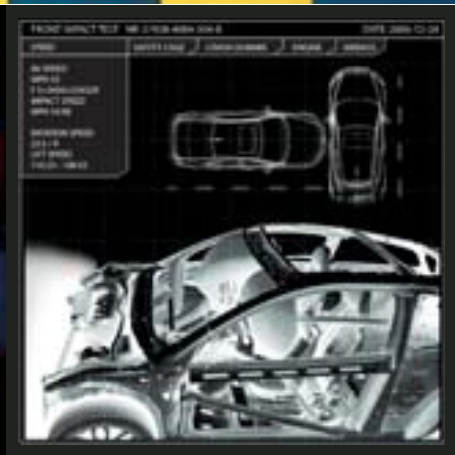

full-scale crash tests each year. These tests are based on what our Accident Research Team discovers on the road. Since 1970, our researchers have investigated over 36,000 real-life accidents. This gives us unique opportunities to learn what works in real life and what doesn't—knowledge that actually helps save lives.

Life-saving knowledge

Many of the safety features found in a Volvo are based on the findings from the Volvo Accident Research Team. A few recent examples are the collapsible steering column, the energy-absorbing frontal structure, Volvo's child safety equipment, the Side-Impact Protection System (SIPS) and the Whiplash Protection System (WHIPS).

Recreating reality into its smallest details

Advanced crash simulations are an important means of conducting realistic crash tests of separate components and interior safety systems. Our crash sleigh can recreate the exact movement the car makes the moment of collision, which is unique in the car world. This tipping affects the way occupants are restrained and is normally only possible to analyze through expensive full-scale crash tests.

Virtual crash tests

Super-computers make it possible for us to recreate and analyze different crash situations six times a day without crashing real cars. We have the technology to test new cars virtually even before they exist as prototypes, and we can incorporate extremely detailed virtual crash test dummies—we've even developed the world's first pregnant crash test dummy. This makes the full-scale testing very effective, and enables us to focus our resources where they are most useful.

⊕ This is living it.



Sweden. Other car manufacturers come here for final car testing under harsh and capricious conditions. For us it's home. This is where we live and drive, 365 days a year. So no wonder Volvos are in a category of their own when it comes to active safety. Take, for example, our own proving ground Hällered with its 34 miles of test tracks—including different road types from all over the world. This is the top secret facility

where we scrutinize our cars' ability to support their driver in all imaginable (and unimaginable) situations. On tracks aimed to reveal any weak spots, we expose all new Volvo models to extreme forces and conditions during hundred thousands of miles. Not to mention the distances driven on ordinary Swedish roads. Here's where innovation confronts reality. Here's also where we evaluate the interaction between the car

and the driver. Because the most important safety feature in a Volvo is the driver. And the more efficiently the car's onboard systems support you as driver, the safer things are for you and your passengers

THE NORDIC LIGHT.

Designed in a country characterized by cold and darkness for several months a year, the headlamps in a Volvo S40 combine separate reflectors to provide even and effective illumination in all conditions. For oncoming traffic, the low beam is highlighted by a single ring of light making it easier to judge the distance to your car. And for even better night vision, there's the option of Active Bi-Xenon gas discharge lamps.

Active Bi-Xenon headlights provide more than twice the high and low beam illumination of conventional halogen headlights. Independent of the load, these headlights self-adjust to maintain the correct angle to the road—even during hard acceleration or braking.



Volvo's new Active Bi-Xenon Lights (ABL) (Optional).

Helps you to see around bends at night, this microprocessor controlled lighting system uses data such as steering wheel angle and car speed to allow the beam of light to follow the road even when cornering. You can enjoy highly effective low beam illumination on narrow, winding roads and extremely powerful high beams on the open road. A daylight sensor disengages the system during the daytime to extend its lifespan, and a high-pressure washer cleans the lenses—half at a time for continuous performance.

See around the corner

Using Active Bi-Xenon Lights (ABL), the motorized lamps turn up to 15° in either direction—faithfully lighting up your chosen path.

Double your illumination—twice

Compared to conventional halogen headlights, Bi-Xenon headlights expand your vision range with about 230%. Driving at 60 mph, you'll be able to see approximately 150 ft farther.

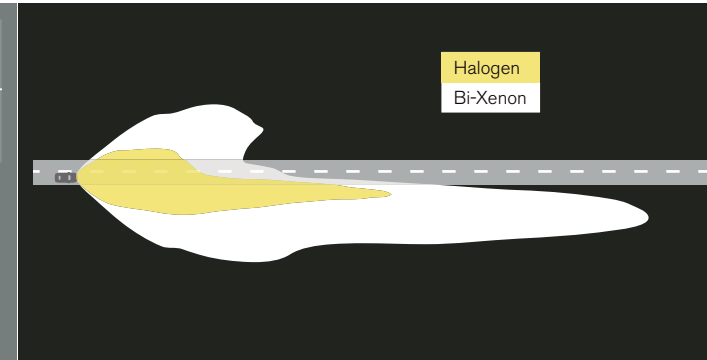
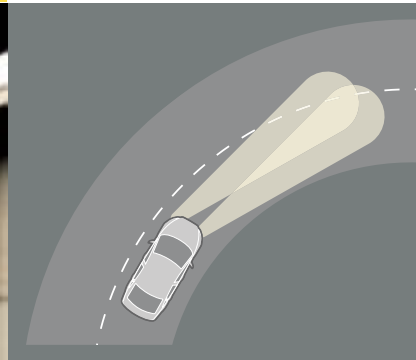

ABS brakes with Emergency Brake Assistance (EBA)

The anti-locking disc brakes are designed for optimal performance even during repetitive and intensive use. You can brake as hard as you like as you steer clear of trouble. EBA detects an attempted emergency braking and, when necessary, provides added assistance to bring the car to standstill in the shortest possible distance.

⊕ Designed for life.



IN A FRONTAL COLLISION the outer deformation zones of the frontal structure will yield to help absorb crash energy. The zones closer to the cabin are more resilient help maintain passenger compartment integrity. The compact power train is designed to help optimize deformation—all main components in the engine bay have their own predetermined positions to help keep components outside the cabin. A steel strut under the dashboard helps prevent components in the engine bay from intruding into the cabin. This also helps protect legs and feet.

The unique geometry of the frontal structure and longitudinal steel struts in the doors helps disperse crash energy away from the front to the rear of the car, further helping to reduce the strain on the occupants.

Inside the car, occupant protection is increased by optimizing the functions of all safety restraint systems. The seat belts with pre-tensioners on all outboard seats and load limiters on the front seats interact with other safety features—such as the steering column that can be deformed horizontally and the dual-stage airbags that adapt inflation to the force of the collision—to help keep the occupants out of harm's way.

The interior is designed to help absorb as much crash energy as possible and to help reduce the risk of injury. For example, the ignition switch is positioned on the dashboard away from the driver's knees.



"To me, safety is beautiful. Every detail in a Volvo—from the interior ergonomics and the fantastic seats, to the body's powerful shoulders and softly rounded front—are there for safety reasons. This is functionality that goes hand in hand with distinctive design, and it sure looks good."

Steve Mattin, Design director, Volvo Car Corporation

It is the interaction between the different safety systems that determines how safe a car is. Not the number of safety features itself. First, the driver must have the right conditions for well being behind the wheel. Seats, instruments, controls, visibility, lighting—all contributes to safety when they interact to support the driver. Then there's how the car behaves on the road. The way the chassis interacts with brakes, steering and

different stability enhancing systems not only determines how fun the car is to drive—this is also crucial to help the driver maintain control in challenging situations. Finally, if an accident can't be avoided, you and your passengers are surrounded by a wealth of interacting protective systems. Hopefully you'll never have to experience them in action. But it can be reassuring to know they're there to help protect you.

IN A ROLL-OVER the extremely sturdy safety cage will help protect the occupants while the seat belts help keep them restrained in their seats. If the car has initially been hit from the side, the Inflatable Curtain (IC) is activated to help protect the heads of the outboard occupants and help keep them inside the car. The IC remains inflated for several seconds to help provide extended protection, regardless of whether the windows are up or down. The energy absorbing interior also adds to occupant protection. Additionally, the roof structure is reinforced to help keep the passenger compartment intact.



IN A REAR IMPACT the rear deformation zones will help absorb as much as possible of the crash energy before it reaches the cabin. Similar to the front, the rear safety structure features an optimized mix of different grades of steel to provide strength and carefully controlled deformation. The fuel tank is designed to remain well protected in front of the rear axle. Even the exhaust system and spare wheel is designed to not affect the energy absorption.

Inside the cabin, the head restraints not only help protect the neck and spine, but also help protect the head from glass shatters. Integrated in the front seats, Volvo's unique Whiplash Protection System (WHIPS) cradles the spine and neck in a controlled manner. The system is activated by a collision of sufficient force from behind. Independent research has shown that WHIPS is one of the most effective in the world. Since its introduction in 1998, it has helped reduce long-term consequences by more than 50%.

IN A SIDE IMPACT the distance between your chest and the colliding car is about 1 foot. So how can we best use this distance to help protect life? To provide strength and carefully controlled deformation in a side impact, the door and side structure in the Volvo S40 is composed of a combination of ultra high strength steel and more pliant grades of steel. The sides of the car body is further reinforced to help withstand a collision with a larger vehicle such as an SUV. The side airbags in the front seats help protect the occupants chest and hip, irrespective of seating position. The Inflatable Curtain (IC) adds protection for the head and helps keep the occupants inside the car, both in the front and the rear. And in the front seats, you'll find strong, rigid side-impact tubes. These transfer the loads from the side of the car into the center of the car, where a steel box is deformed. So in a Volvo S40 there is actually one extra crumple zone in the center of the car.



 Environmental care.
Part of our commitment to
safety and your well being.

At Volvo, the well being of people is at the core of every decision we make. And just like safety, we believe that environmental care requires a holistic approach from the very start. For this reason, Volvos are built in some of the cleanest automotive plants in the world.

**Air quality control**

A cabin filter helps to prevent dust and pollen from entering the car through its ventilation system.

Testing materials for harmful substances

To make life more comfortable for people with allergies or asthma, upholsteries and interior textiles comply with the Oeko-Tex Standard 100—an international benchmark ensuring that textiles and leathers are tested for certain allergy inducing or harmful substances. All interior metal details are tested with regard to contact allergies—so parts such as keys, door handles and seat belt buckles comply with the same standards for nickel leakage as high quality jewelry.

Fuel efficiency

To increase fuel efficiency and reduce carbon dioxide emissions, all Volvo engines have advanced electronic management systems and low internal friction. Other factors that contribute to fuel economy include efficient transmission systems, aerodynamic body design, the use of various grades of steel to minimize body weight, and a trip computer displaying current and average fuel consumption.

Emission control

Volvo engines meet stringent international emission requirements. Advanced emission control technology eliminates between 95 and 99% of the carbon monoxide, hydrocarbons and nitrogen oxides in exhaust fumes. The emission control system is designed to provide full effect as rapidly as possible after a cold start—when emissions are at their highest. Right down to the fuel filler door, the fuel system is designed to reduce emissions through evaporation when the car is moving or at a standstill.

Clean all its life

Every Volvo begins its relationship with the environment at the earliest stage of its design. Volvos are built in some of the cleanest automotive plants in the world. What's more, our Environmental Product Information (EPI) allows you to choose a Volvo model on the basis of its overall environmental performance.





Factory-installed options.

The sense of quality and care—and knowing that you get the Volvo that suits your lifestyle. Customize your car with the options that best meet your demands and desires, and you'll soon be behind the wheel of your individually tailored Volvo S40.

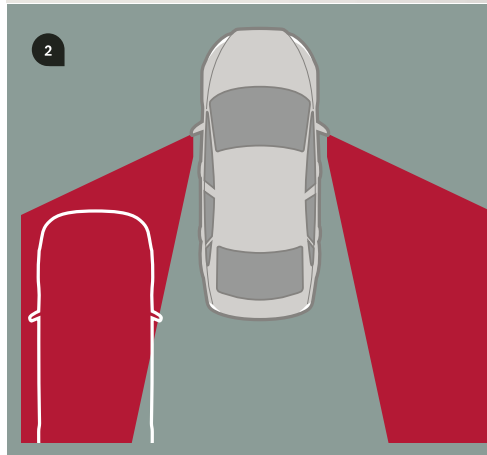

1

Keyless drive

Keyless drive lets you lock, unlock and start the car without having the remote control in your hand. As long as you have the remote with you, grasping the door handle automatically unlocks the door. To start the engine, simply turn the control on the instrument panel. To lock the doors, just press a button in the door handle as you leave the car.

2

Blind Spot Information System (BLIS)

The next best thing to having eyes in the back of your head, BLIS is there to help when you're changing lanes. Rear-facing cameras in the power folding door mirrors help detect vehicles moving into your blind spot and alert you of their presence. BLIS doesn't make any decisions for you, but it does help to keep you informed. BLIS is activated once the car exceeds 6 mph, and reacts to almost any type of vehicle from a motorcycle upwards. Day or night.

3

Active Bi-Xenon Lights (ABL)

Active Bi-Xenon headlights help you to see around bends at night. Controlled by microprocessors, the motorised lamps turn up to 15° in either direction—faithfully lighting up your chosen path. A twilight sensor disengages the system during daylight to extend its lifetime and a high-pressure washer cleans the lenses—one side at a time for optimum performance. Bi-Xenon headlights provide twice the illumination of conventional halogen headlights but use less power.

4

Chromed Zaurak alloy wheels

These sporty 17" wheels gives your car the perfect mix of looks and handling.

5

Volvo Navigation System (VNS)*

Guides you anywhere with precise audio and visual directions. Using the global positioning satellite system, a liquid crystal 6.5-inch display shows your location on a map and plots the best route to your destination. Controls are conveniently located on the steering wheel. When not in use, the screen retracts into the dashboard. All map-based information is stored on DVD discs.

*Maps do not cover all areas or all routes within an area. Also constant expansion and rebuilding of the road network mean that the digital map database is not always the latest road and traffic information. Always follow relevant regulations and road information.

Accessories.

Volvo's accessories help you make your Volvo S40 even better suited to your personal needs. They are the only ones that have been tested to meet Volvo's exacting safety, quality and environmental requirements. You can also rest assured they're a perfect match to the technology and design of your Volvo.



FOR DRIVING FREEDOM

Fog lights
Home link
Moon roof wind deflector
Park assist, front and rear
Volvo Hands free with Bluetooth

FOR YOUR ENTERTAINMENT

Satellite Radio
Subwoofer
Volvo iPod Aux Adapter
Volvo USB and iPod music player

FOR PRECIOUS CARGO

Booster cushion and backrest
Child Activity Bag
Child Mirror
Comfort Upholstery and head support
Padded neck cushion
Rear center armrest table
Sun screens

FOR YOUR LEISURE

Ashtray, front and rear
Bike carrier, roof mounted
Canoe/Kayak carrier, roof mounted
Cargo box, roof mounted
Electric cooler / hotbox

Grocery Bag Holder

Load basket, roof mounted
Load Securing Straps
Luggage Compartment mats
Roof Mounted "Load Bar"
carrying system
Rubber Floor Mats
Ski Carriers, roof mounted
Snowboard carrier, roof mounted
Sunglass holder
Surfboard carrier, roof mounted
Trailer Hitch, Square profile
Trailer Mirrors
Tunnel Mat

FOR UNEXPECTED SITUATIONS

Car Cover
Engine Block Heater
First aid kit
Jumper cables
Leather care kit
Mud Flaps
Snow Chains
Warning triangle

FOR YOUR LOOKS

Aluminum Wheels
Chrome Wheels
Gear shift Knobs
Interior décor panel kits
License plate frames
Sport Body Kit
Sport Floor Mats
Steering wheel, Sport
Steering wheel, wood
Trunk Spoiler
Valve stem caps
Wood Trim kit

Interior selection.



Dalarö Offblack in Offblack interior (5C77)
Nordic Light Oak center stack and door panel inserts.



Leather Offblack in Offblack interior (5D77)
Aluminum center stack and door panel inserts.



Bauxite center stack
and door panel inlays



Aluminum center stack
and door panel inlays



Nordic Light Oak center stack
and door panel inlays

The Volvo S40 offers exclusive interior options to suit your personality. All of our leather and fabric upholstery are approved by Oeko-Tex. This means they're tested for certain allergy-inducing and harmful substances. Make your choices to compose your own interior styling.



Dalarö Quartz in Dark Beige interior (5CE1)
Aluminum center stack and door panel inserts.



Leather Quartz in Dark Beige interior (5DE1)
Nordic Light Oak center stack and door panel inserts.



Leather-clad steering wheel



Leather-clad sports steering wheel with aluminum inlay



Leather-clad gear knob, manual



Leather-clad gear knob, Geartronic



Leather-clad gear knob with aluminum inlay, Geartronic

Exterior selection.



When you see this S40 on the road you could be excused for looking twice. It would be no surprise if you first admired its tough mean appearance. You could be forgiven for losing yourself in its sporty contours and dwelling on an unfathomable, almost dangerous attraction. Then you could be excused for pinching yourself when you learn it's a Volvo – with a difference. From outside you'll immediately appreciate attractive exterior styling including a bodykit, trunk spoiler, double endpipes and 17" Zaurak wheels. On the inside the sports steering wheel and sports gearshift knob with aluminum inlays complete the sporty appearance of the S40 with the Dynamic Trim Package.



Ceryx 6.5x16" alloy wheels
Silver Stone
(std. T5, T5 AWD)



Cursa 6.5x16" alloy wheels
Silver Bright
(std. 2.4i)



Serapis 7x17" alloy wheels
Silver Bright
(2.4i Select Package)



Spartacus 7x17" alloy wheels
Silver Bright
(T5 Premium Package)



Zaurak 7x17" alloy wheels
Silver Bright
(T5 Dynamic Trim Package)



Zaurak 7x17" alloy wheels
Chromed
(opt. T5, T5 AWD)



Trunk spoiler

Color coordinated with the body of the car, this trunk spoiler enhances the sporting character of your Volvo S40. Available as a retailer installed accessory.



Sport textile mats

The reflective inserts further heighten the ambience of the interior and perfectly match other interior sport styling extras such as the sport steering wheel and gear knob. Available as a retailer installed accessory.

Standard features.

SAFETY & SECURITY	S40 2.4i	S40 T5	S40 T5 AWD
Automatic hazard warning lights	●	●	●
Anti-submarine seats	●	●	●
Daytime running lights	●	●	●
Driver and front passenger supplemental restraint system, dual threshold airbags	●	●	●
Dynamic Stability and Traction Control (DSTC)	●	●	●
Electronic key integrated remote	●	●	●
Emergency trunk release	●	●	●
Illuminated side marker lights	●	●	●
Inflatable side Curtains (IC)	●	●	●
Immobilizer encrypted ignition key	●	●	●
Overhead-mounted seat belt reminder	●	●	●
Rear-door child safety locks	●	●	●
Safe approach and home safe lighting	●	●	●
Safety cage passenger compartment	●	●	●
Security system	●	●	●
Side Impact Protection System (SIPS)	●	●	●
Side impact air bags for driver and front passenger	●	●	●
Whiplash Protection Seating System (WHIPS)	●	●	●
INTERIOR	S40 2.4i	S40 T5	S40 T5 AWD
Aluminum trim	P	●	●
Bauxite trim	●	N/A	N/A
Cruise control	●	●	●
Dala T-Tec seating surfaces	●	●	●
Driver's seat with tilt, recline, adjustable lumbar support	●	●	●
Electronic Climate Control (ECC)	N/A	●	●
Ergonomically designed seats	●	●	●
Forward folding front passenger seat	●	●	●
Four cup holders	●	●	●
Four reading lights	●	●	●
Front door storage pockets	●	●	●
Front seat-back storage pockets	●	●	●
High Performance audio with in-dash 6-CD, amplifier, 8 speakers	N/A	●	●
Illuminated vanity mirrors	●	●	●
Interior cabin light delay	●	●	●
Leather-clad gear knob	P	●	●
Leather-clad steering wheel	●	●	●
Manual climate control with air conditioning	●	N/A	N/A
Nordic Light Oak Trim	○	N/A	N/A
Outside temperature gauge	●	●	●
Performance audio with in-dash CD, amplifier, 6 speakers	●	N/A	N/A
Pollen filter	●	●	●
Power adjustable driver's seat	P	●	●
Power windows	●	●	●
Plush floor mats	●	●	●
Remote audio controls in steering wheel	●	●	●
Tilt/telescopic steering wheel	●	●	●
Ultra-slim center control panel	●	●	●

EXTERIOR	S40 2.4i	S40 T5	S40 T5 AWD
Front fog lights	P	●	●
Polished exhaust tail pipes	N/A	●	●
6.5x16" Cursa alloy wheels	●	N/A	N/A
6.5x16" Ceryx alloy wheels	N/A	●	●

● = Standard P = Package N/A = Not available

Factory options.

	S40 2.4i	S40 T5	S40 T5 AWD
Active Bi-Xenon headlights with cleaning washers	N/A	○	○
BLIS with power retractable mirrors	○	○	○
Geartronic automatic transmission	○	●	●
Keyless Drive	N/A	○	○
Leather seating surfaces	○	P	P
Metallic paint	○	○	○
Sirius satellite radio	P	●	●
Volvo Navigation System (VNS)	N/A	○	○
7x17" Serapis alloy wheels	P	N/A	N/A
7x17" Spartacus alloy wheels	N/A	P	P
7x17" Zaurak alloy wheels	N/A	P	P
7x17" Zaurak (chromed) alloy wheels	N/A	○	○

● = Standard ○ = Option P = Package N/A = Not available

Packages.

CLIMATE PACKAGE (2.4i, T5, T5 AWD)

In a Volvo you're always prepared to deal with the ever-changing forces of nature. And to increase comfort when driving in cold, rain or snow simply add the Climate Package.

- Headlight washers
- Heated front seats
- Rain sensor

DYNAUDIO SOUND SYSTEM PACKAGE (T5, T5 AWD)

Combines the Premium Sound with Dynaudio package for a concert hall listening experience. The power of Dolby Pro Logic II teams with an in-dash 6-CD changer to make your drive even more enjoyable by putting a broad range of your favourite music within easy reach.

- RDS Radio
- MP3 and WMA compatible CD player
- 12 speakers by Dynaudio
- 5x130 W digital Class D amplifier
- Dolby® Pro Logic® II surround sound
- AUX input

DYNAMIC TRIM PACKAGE* (T5, T5 AWD)

A Volvo is designed to move you even when standing still. And to further boost the dynamic looks of your car, there's always the option of Volvo's Dynamic Trim Package.

- Dynamic chassis T5
- Front and trunk lid spoilers
- Lower rear valance
- Side sill moldings/lower door edge moldings
- Sport gearshift knob with aluminum inlay
- Sport steering wheel with aluminum inlay
- 17" Zaurak alloy wheels

*Requires Premium Package

PREMIUM PACKAGE (T5, T5 AWD)

A Volvo offers you long, relaxed drives and a more spirited everyday life. The Premium Package will provide you with some necessities for that extra ambience and convenience.

- Auto dimming and compass in rear view mirror
- Homelink
- Memory function for driver's seat
- Power passenger seat
- Power glass moonroof
- 17" Spartacus wheels
- Leather Seating surfaces
- Leather hand brake

SELECT PACKAGE (2.4i)

A Volvo offers you long, relaxed drives and a more spirited everyday life. The Select Package will provide you with some necessities for that extra ambience and convenience.

- MP3 capability
- Power glass moonroof
- Power driver's seat
- Trip computer
- 6-CD player
- 17" Serapis wheel
- High Performance Sound System
- Sirius™ Satellite Radio
- Fog lights
- Nordic Light Oak or Aluminum trim
- Leather Gearshift knob

Volvo S40 specifications.

ENGINES

Five-cylinder in-line engine. Double overhead camshafts, 20 valves. Continuously variable valve timing on the intake side (2.4i) or both the intake and exhaust side (T5). Electronic engine management system. Three-way catalytic converter with heated oxygen sensor. T5 also features light-pressure turbocharger and dual-charge air coolers (Intercoolers).

Volvo's smooth-running five-cylinder engines are designed to respond at low rpm, so there's plenty of torque without having to shift to a lower gear. This is made possible by continuously variable valve timing, low internal friction and the electronic engine control system. This also helps to optimize fuel consumption and reduce environmental impact—all engines comply with stringent emission standards, such as California's ULEV II. And for even more exhilaration and acceleration, there's the turbocharged T5 engine.

Volvo S40 2.4i (168 hp)

Engine type: 2.4-liter five-cylinder
Max. power output: 168 hp at 6000 rpm
Max. torque: 170 ft./lbs. at 4400 rpm
Acceleration 0–60 mph, man/auto: 7.7/8.4 sec.
Top speed: 130 mph
Fuel consumption, mpg, city/highway, man: 22/29
Fuel consumption, mpg, city/highway, auto: 22/30
Carbon dioxide emissions CO₂ g/km, man/auto: 203/217
Environmental classification: ULEV II
Transmission: Five-speed manual or five-speed Geartronic automatic

Volvo S40 T5 (227 hp)

Engine type: 2.5-liter five-cylinder turbocharged
Max. power output: 227 hp at 5000 rpm
Max. torque: 236 ft./lbs. at 1500-4800 rpm
Acceleration 0–60 mph, auto: 6.7 sec.
Top speed: 130 mph
Fuel consumption, mpg, city/highway, auto: 22/31
Carbon dioxide emissions CO₂ g/km, auto: 224
Environmental classification: ULEV II
Transmission: Five-speed Geartronic automatic

Volvo S40 T5 AWD (227 hp)

Engine type: 2.5-liter five-cylinder turbocharged
Max. power output: 227 hp at 5000 rpm
Max. torque: 236 ft./lbs. at 1500-4800 rpm
Acceleration 0–60 mph, auto: 7.0 sec.
Top speed: 130 mph
Fuel consumption, mpg, city/highway, auto: 20/28
Carbon dioxide emissions CO₂ g/km, auto: 229/241
Environmental classification: ULEV II
Transmission: five-speed Geartronic

DRIVELINE

Front wheel drive. (T5 AWD features an electronically controlled all-wheel drive system). Transverse engine. Five-cylinders: Five-speed (2.4i) all-synchromesh manual transmission. 2.4i is available with a five-speed Geartronic automatic allowing manual shifting. A five-speed Geartronic is standard with the T5 and T5 AWD.

The smooth manual five-speed transmission inspires an active driving style. For the best of both worlds, there's the Geartronic—a responsive five-speed automatic for relaxed driving. It can also be shifted manually so that you can maintain a lower gear to rev the engine or provide the added assistance of engine braking.

CHASSIS

Front suspension with spring struts (McPherson), anti-dive and anti-lift function. Multilink independent rear suspension. Stabilizer bars front and rear. DSTC (Dynamic Stability and Traction Control).

The rigid body enables the suspension to perform optimally—for well balanced handling and a high level of comfort. The front and rear suspensions also interact to provide stable braking and smooth steering. The DSTC stability system assists if either of the drive wheels begins to lose traction or if a skid is imminent.

STEERING

Power-assisted electro-hydraulic rack and pinion steering. Tilt and telescopic steering wheel column. 2.9 turns lock to lock. Turning circle 34.9 ft (depending on tires).

Behind the wheel, you can enjoy responsive yet firm steering at all speeds. High steering precision and balanced road feedback are easily enjoyed benefits.

BRAKES

Power-assisted anti-locking disc brakes (ABS), ventilated discs front. EBA (Emergency Brake Assistance). EBD (Electronic Brake Distribution) between the front and rear brakes. Diagonally split braking system.

Powerful anti-locking disc brakes help ensure a short stopping distance under all circumstances and withstand tough use without fading. EBA helps you use your brakes to the full in an emergency situation, while EBD distributes the braking effect between the front and rear wheels in order to achieve optimal results according to the car's load and driving conditions.

FUEL TANK

15.9 gallons (2.4i and T5)
15 gallons (T5 AWD)

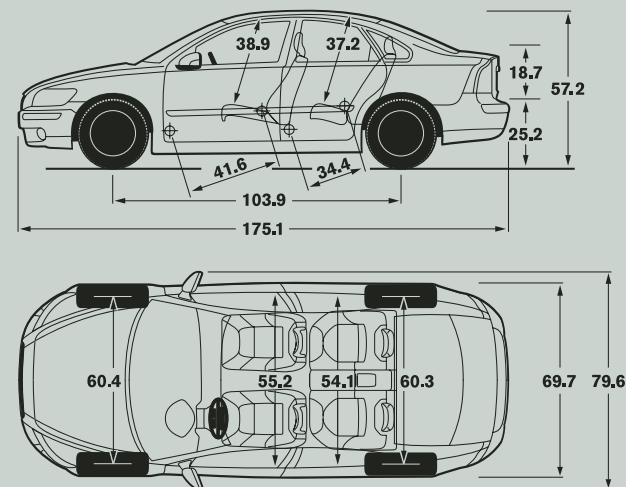

Meet the family.

To live life is to care about it.

S



The new Volvo S40 The compact and energetic sedan.



Volvo S60 The sports sedan worth getting passionate about.



Volvo S80 The premier sedan, meticulously engineered for superior driving comfort.

V



The new Volvo V50 The Sportswagon—flexible, compact and full of zest.



The all-new Volvo V70 The genuine family wagon—highly competitive yet comfortably versatile.

XC



The all-new Volvo XC70 The rugged yet stylish all-roader.



Volvo XC90 The versatile SUV that takes you anywhere with grace.

C



The new Volvo C30 The compact and charismatic SportsCoupe.



Volvo C70 A convertible when you want it.



Volvo C70 A coupe when you need it to be.

Every moment in a Volvo is a moment designed to celebrate life. A life full of twists and turns, ups and downs; the little things as well as the big ones. Of course, to live life to its fullest isn't just about you caring for others is important as well.

For almost eighty years we have helped save lives on roads around the world. Nevertheless, when it comes to improving automotive safety, we will never be satisfied. And while we're seeking new solutions, our existing safety systems are preventing many accidents from happening and providing some real protection when they do.

Our passion for life means looking after our children's children, too. Which is why we try to balance the needs of our company with those of society. With this bigger picture in mind, we develop engines and technology that have less impact on mother earth. This approach also explains why we pay so much attention to your immediate environment—in the car. Simply put, we care about you—and the whole circle of life.

Taking care of your ownership needs.

It's a simple idea; one point of contact for all your car ownership needs, whether it's finding the right financing or who to contact in an emergency.

Get the most out of owning your Volvo.

Volvo Car Finance North America

If you purchase or lease your Volvo through Volvo Car Finance North America, you can take advantage of services designed to make financing simple and convenient. Quick Debit, for instance, enables you to have your monthly payment automatically debited from a designated bank account. For more information, call 1-800-770-8234 or visit www.volvofinance.com

On Call roadside assistance

Whenever you need us, we're just a phone call away. Our nationwide network of retailers and authorized service providers are ready to assist. Whether you require roadside assistance or maps and routing information for your next trip, refer to your On Call Card and dial 1-800-63-VOLVO—anytime, day or night. Your complimentary four-year membership activates the moment you become a Volvo owner.

Volvo new car warranty

Your new car warranty provides comprehensive coverage for four years or 50,000 miles, whichever occurs first. Additional warranties cover corrosion, seat belts, the supplemental restraint system, emission systems, genuine Volvo replacement parts and genuine Volvo accessories. Should you encounter any problem with your Volvo, simply contact the nearest retailer for assistance. Where your warranty ends, Volvo Increased Protection (VIP) plans begin. To purchase the additional protection of a VIP plan, contact your local retailer.

Volvo genuine service

The best way to ensure superior performance year after year is to bring your Volvo to your authorized retailer for regular maintenance. Our service advisors and factory-trained technicians are uniquely qualified to maintain your automobile. With the aid of advanced Volvo diagnostics, they follow all prescribed factory maintenance outlined in your service interval manual. Genuine Volvo Service is our ongoing commitment to you: to keep your Volvo performing smoothly long after other cars have given up.

Volvo mobility program

The goal of the Volvo Mobility Program is to assist persons with physical disabilities or hearing impairment achieve independence. For those with exceptional transportation needs, freedom can be facilitated within the extraordinary comfort and safety of a specially adapted Volvo. For additional information on this program, please contact the Volvo Mobility Program Headquarters at (800) 803-5222 or visit www.volvocars.us/mobility. TTY users are invited to call 1-800-833-0312.

Personal shopper

The Volvo Personal Shopper is dedicated to providing you with a whole new level of shopping convenience. Whether you'd like help identifying the Volvo model that best fits your lifestyle, detailed information on any Volvo model, or a comparison against the competition, Volvo is there to help. We can arrange a Guest Drive for you at your nearest Volvo Retailer. So make the most of your shopping time and call the Volvo Personal Shopper at 1-800-550-5658. (U.S. only)

Volvo Overseas Delivery.

Volvo Overseas Delivery offers a unique way to buy your new custom-built car as well as a unique way to see more of Europe. And when you're done traveling, bring the pleasure of driving a Volvo back home. Purchase any new Volvo as part of the Volvo Overseas Delivery Program and enjoy all this—and more:

- Attractive pricing on US models.
- Two complimentary round-trip tickets with Scandinavian Airlines.
- One free hotel night in Gothenburg, Sweden, the home of Volvo.
- An exciting Volvo Factory Tour or a visit to the new Volvo Brand Experience Center.
- An exclusive VIP delivery experience at the Volvo Factory Delivery Center.
- The opportunity to explore Europe in the comfort and safety of your own Volvo, either with one of our spectacular tours or on your own.
- Extensive complimentary home shipment services. Just leave your car with us. We'll ship it to you the convenient way while you relax and enjoy your complimentary flight back home.

Can you think of a better way of traveling overseas and making your souvenir part of an unforgettable experience?

If you would like to know more, contact your local Volvo retailer, our Customer Care Center (800) 631-1667, or visit www.volvocars.us/mybagsarepacked

A world of colors.



614 Ice White



466 Barents Blue metallic*



488 Gecko Green metallic*



426 Silver metallic*



455 Titanium Grey metallic*



612 Passion Red



490 Chameleon Blue metallic*



019 Black Stone

* Metallic paint is an option.

Please note: It is not possible to reproduce exact original shades in this brochure. Ask your Volvo retailer to show you samples. As part of our commitment to the environment, the paper used in this brochure is recycled, and color choices were printed directly on the page. This eliminates the need for chemically treated color chips. A small thing perhaps, but then, every little bit helps.

Volvo. for life

VOLVO
Volvo Car Corporation

WWW.VOLVOCARS.US

Specifications, features, and equipment shown in this catalog are based upon the latest information available at the time of publication. Volvo Cars of North America, LLC reserves the right to make changes at any time, without notice, to colors, specifications, accessories, materials, and models. For additional information, please contact your authorized Volvo retailer.

© 2007 Volvo Cars of North America, LLC. Printed in USA on 100% recyclable paper. **MY08A**