

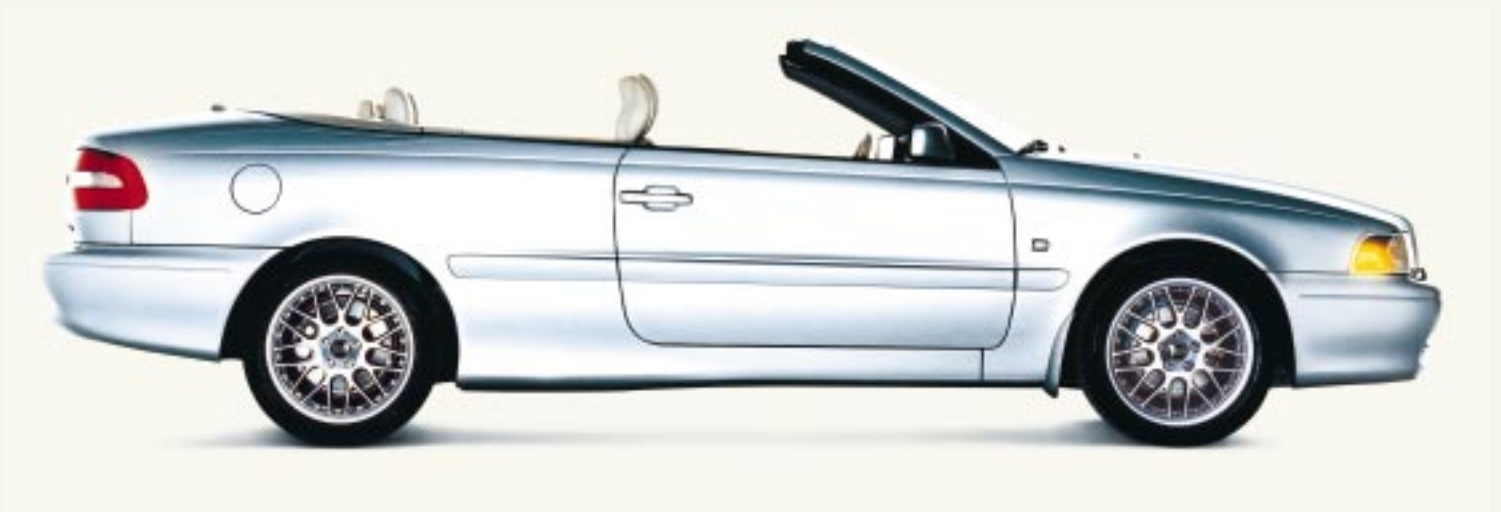

VOLVO
C70 PRICING

VOLVO
for life



THE VOLVO C70

The rare combination of performance, precision and stability makes it easy to enjoy life behind the wheel of a Volvo C70 Convertible. The sense of freedom and exhilaration is never further away than the touch of a button combining the performance of three petrol engines ranging between 163 bhp and 245 bhp and two generous specification levels. With unique safety solutions like our protection systems for side collisions, rear collisions and roll-over accidents make the Volvo C70 Convertible one of the world's safest open cars.

T5

The T5 2.3 litre, turbocharged, in-line, 5 cylinder engine delivers outstanding performance – producing 245 bhp and 330 Nm torque. This extremely smooth engine features variable valve timing on the exhaust side and a responsive turbocharger designed to deliver maximum torque from low and medium engine speeds. Effortless performance and refinement are balanced with excellent fuel consumption.

DOLBY SURROUND PRO LOGIC

The Volvo C70 was the first car in the world to be available with the Dolby Pro Logic Surround System^{TM(ii)}. The Pro Logic option adds an audio processor and a centre loudspeaker to the existing high performance sound system and delivers a 'wrap around' sound which transforms the car into a concert hall.

CHOOSE YOUR VOLVO	2-3
STANDARD AND OPTIONAL EQUIPMENT	4-5
ACCESSORIES & UPHOLSTERY	6-7
TECHNICAL SPECIFICATION	8-9
CHOOSE YOUR COLOUR	10
CARE BY VOLVO	11

C70

The comprehensive standard specification includes full electric soft top, glass rear screen, wind deflector, electronic climate control, full leather faced upholstery, 16" Ceres alloy wheels, cruise control and a 10-speaker CD player – not forgetting ROPS (Roll-Over Protection System), ABS, EBD and a full complement of front and side airbags.

PETROL

C70 2.0T

Basic £

£20,595.74

VAT £

£3,604.26

Rec Retail Price £

£24,200.00

On The Road Price £

£24,860.00

On The Road Price €⁽ⁱ⁾ Euros

€38,234.68

C70 GT

The GT specification offers two additional engines, the 245 bhp T5 and 200 bhp 2.4T. In addition, a comprehensive information centre, heated front seats, 3 x CD player with Dolby Pro Logic Surround System^{TM(ii)} and 17" Cratos alloy wheels add to the already comprehensive standard specification.

PETROL

C70 2.0T GT

Basic £

£22,042.55

VAT £

£3,857.45

Rec Retail Price £

£25,900.00

On The Road Price £

£26,560.00

On The Road Price €⁽ⁱ⁾ Euros

€40,849.28

C70 2.4T GT

£23,489.36

£4,110.64

£27,600.00

£28,260.00

€43,463.88

C70 T5 GT

£24,936.17

£4,363.83

£29,300.00

£29,960.00

€46,078.48



(i) Euro prices shown are for information only and are calculated using an exchange rate of 1.538 Euros to the £, as published in the Financial Times on 6th January 2003. Euro prices will be subject to the prevailing exchange rate at the time of purchase. These figures are for information purposes only.

(ii) Dolby and Pro Logic Surround SoundTM are trademarks of the Dolby Laboratories Licensing Corporation.

	C70	C70 GT
SAFETY & SECURITY		
Driver and Passenger Airbags	•	•
SIPS (Side Impact Protection System)	•	•
SIPS Airbags	•	•
ROPS (Roll Over Protection System)	•	•
WHIPS (Whiplash Protection System) (Front Seats)	•	•
ABS (Anti-lock Brakes) with EBD (Electronic Brake Distribution)	•	•
STC (Stability and Traction Control)	•	•
4 Three Point Seat Belts	•	•
Seat Belt Pre-tensioners (Front)	•	•
Head Restraints – All 4 Seats	•	•
Anti-theft Alarm and Immobiliser	•	•
Remote Control Central Locking including Fuel Flap with Deadlocking System	•	•
Mass Movement Sensor	•	•
Tinted Windows	•	•
Visible VIN Plate	•	•
Day Running Lights	•	•
Headlamp Levelling System	•	•
High Level LED Brake Light	•	•
Home Safe Lighting	•	•
INTERIOR		
ECC (Electronic Climate Control) and Pollen Filter	•	•
Exterior Temperature Gauge	•	•
Information Centre	•	•
Cruise Control	•	•
Front and Rear Electric Windows	•	•
Electrically Adjustable and Heated Door Mirrors	•	•
Illuminated Driver and Passenger Vanity Mirrors	•	•
Front and Rear Reading Lamps	•	•
Autodimming Rear View Mirror	•	•
Front Cupholders	•	•
Height Adjustable Driver and Passenger Seats	•	•
Driver and Passenger Seat Mechanism for Access to Rear	•	•
Heated Front Seats	•	•
Front Centre Armrest	•	•
Leather Steering Wheel	•	•
Leather Sports Steering Wheel (Dark Grey)	•	•
Leather Handbrake Lever and Gear Knob	•	•
Height and Reach Adjustable Steering Column	•	•
Patterned Aluminium Trim	•	•
Leather-faced Upholstery	•	•
Luxury Floor Mats	•	•
SC-805 RDS Single Slot CD Stereo Radio Cassette, 4 x 60W Amplifier with Auto Sound Control	•	•
SC-901 RDS 3 x CD Radio Cassette, 4 x 100W Amplifier with Dolby Pro Logic Surround Sound™(iii) and 9" Subwoofers Behind Rear Seat	•	•
EXTERIOR		
16" Ceres Alloy Wheels – 225/50 ZR16 Tyres	•	•
17" Cratos Alloy Wheels – 225/45 ZR17 Tyres ^(iv)	•	•
Locking Wheels Nuts	•	•
Tempa Spare Wheel	•	•
Front Fog Lights	•	•
Headlamp Wash/Wipe	•	•
Comfort Chassis (2.0T/2.4T only)	•	•
Dynamic Chassis (T5 only)	•	•
Colour Co-ordinated Bumpers and Door Mirrors	•	•
Aluminium Sill Covers	•	•
Wind Deflector	•	•
Full Electric Soft Top (Black) with Glass Rear Screen	•	•



	Basic £	VAT £	Rec Retail Price £	Rec Retail Price € ⁽ⁱ⁾	C70	C70 GT
SAFETY & SECURITY						
Delete Passenger Airbag	–	–	–	–	nco	nco
Inclination Sensor	£106.38	£18.62	£125.00	€192.25	o	o
INTERIOR						
Automatic Transmission	£936.17	£163.83	£1,100.00	€1,691.80	o	o
Information Centre	£272.34	£47.66	£320.00	€492.16	o	•
First Aid Kit	£21.28	£3.72	£25.00	€38.45	o	o
Electric Driver and Passenger Seats (with Memory)	£936.17	£163.83	£1,100.00	€1,691.80	o	o
Heated Front Seats	£127.66	£22.34	£150.00	€230.70	o	•
Leather Sports Steering Wheel (Dark Grey)	£85.11	£14.89	£100.00	€153.80	o	•
Red Wood/Leather Steering Wheel (n/a with Light Wood Effect Inlays)	£85.11	£14.89	£100.00	€153.80	o	nco
Red Wood Inlays/ Red Wood Gear Knob (Gear Knob Auto only)	–	–	–	–	nco	nco
Light Wood Effect Inlays/Light Wood Effect Gear Knob (Gear Knob Auto only)	–	–	–	–	nco	nco
Soft Leather Upholstery	£297.87	£52.13	£350.00	€538.30	o	o
SC-901 RDS 3 x CD Stereo Radio Cassette (including 4 x 100W Amplifier)	£468.09	£81.91	£550.00	€845.90	o	nco
SC-901 RDS 3 x CD Stereo Radio Cassette, 4 x 100W Amplifier with Dolby Pro Logic Surround Sound™(iii) and 9" Subwoofers Behind Rear Seat	£978.72	£171.28	£1,150.00	€1,768.70	o	•
Rear 6 x CD Autochanger	£255.32	£44.68	£300.00	€461.40	o	o
RTI Navigation System with UK Disc Map ^(vi)	£2,127.66	£372.34	£2,500.00	€3,845.00	o	o
Mobile Phone Kits	Please consult your nearest Volvo dealer for latest information and prices.					
EXTERIOR						
Black Paint (Solid)	£212.77	£37.23	£250.00	€384.50	o	o
Metallic/Pearlescent Paint	£425.53	£74.47	£500.00	€769.00	o	o
16" Zeus Alloy Wheels – 225/50 ZR16 Tyres (2.0T only)	–	–	–	–	nco	nco
17" Comet Alloy Wheels – 225/45 ZR17 Tyres	£255.32	£44.68	£300.00	€461.40	o	nco
17" Cratos Alloy Wheels – 225/45 ZR17 Tyres	£255.32	£44.68	£300.00	€461.40	o	•
17" Propus Alloy Wheels – 225/45 ZR17 Tyres	£425.53	£74.47	£500.00	€769.00	o	u (£200)
Park Assist, Rear ⁽ⁱⁱ⁾	£316.03	£55.31	£411.32	€571.12	o	o
Sports Exhaust System ^(iv)	£425.53	£74.47	£500.00	€769.00	o	o
Load Compensating Suspension ^(v)	£425.53	£74.47	£500.00	€769.00	o	o
Dynamic Chassis (Standard Height) (2.0T, 2.4T only)	£85.11	£14.89	£100.00	€153.80	o	o
Lowered Dynamic Chassis ^(vi) – (NCO – T5)	£170.21	£29.79	£200.00	€307.60	o	o
Full Electric Soft Top (Blue) with Glass Rear Screen	–	–	–	–	nco	nco



16" Zeus



16" Ceres



17" Cratos



17" Propus



17" Comet

• = standard, o = optional, nco = no cost option, u (£) = upgrade.

(i) Euro prices shown are for information only and are calculated using an exchange rate of 1.538 Euros to the £, as published in the Financial Times on 6th January 2003.

Euro prices will be subject to the prevailing exchange rate at the time of purchase. These figures are for information purposes only.

(ii) Indicates total fitted price. At participating dealers only. To find out who is a participating dealer contact the Volvo Helpline number on 0800 400 430.

(iii) Dolby and Pro Logic Surround Sound™ are trademarks of Dolby Laboratories Licensing Corporation.

(iv) Cannot be ordered in conjunction with one another.

(v) Cannot be ordered in conjunction with Dolby Pro Logic Surround Sound™(iii) – must be ordered with SC-901 RDS 3 x CD Stereo Radio Cassette.

(vi) The nco 16" alloy wheels will provide a more comfortable ride than the standard 17" alloy wheels.

ACCESSORIES	Basic £	VAT £	Rec Retail Price £	Rec Retail Price € ⁽ⁱ⁾
EXTERIOR ACCESSORIES (PRICES EXCLUDE FITTING UNLESS SHOWN OTHERWISE).				
Load Carrier (boot lid)	£204.26	£35.74	£240.00	€369.12
Load Carrier Brake Lamp	£24.68	£4.32	£29.00	€44.60
MOBILE PHONE KITS Please consult your nearest Volvo dealer for latest information and prices.				

(i) Euro prices shown are for information only and are calculated using an exchange rate of 1.538 Euros to the £, as published in the Financial Times on 6th January 2003. Euro prices will be subject to the prevailing exchange rate at the time of purchase. These figures are for information purposes only.

For further information and a complete list of all Volvo Accessories, just take a look at the new Accessory website at www.volvocars.co.uk/accessories



UPHOLSTERY	Code	Upholstery/Door Insert Colour	Headliner Colour
Leather-faced	1944	Granite	Papyrus
	1966	Light Beige	Light Beige
	1970	Grey	Papyrus
Soft Leather	17B6	Light Beige	Light Beige
	17AO	Red	Papyrus
	1770	Grey	Papyrus

UPHOLSTERY

LEATHER



Light Beige (1966)



Granite (1944)



Grey (1970)

SOFT LEATHER

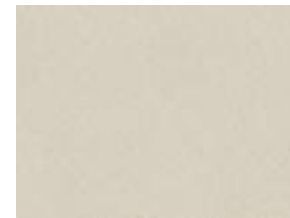

Linen White (17B6)



Volcano Red (17AO)



Grey (1770)

INTERIOR INLAYS



Red Wood



Patterned Aluminium



Light Wood Effect

HOOD COLOUR

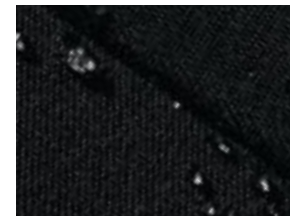

Black (standard)

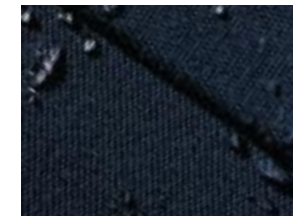

Navy Blue

ENGINE	2.0T	2.4T	T5
Configuration	Transverse – 20 valve	Transverse – 20 valve	Transverse – 20 valve
Cylinders	5	5	5
Engine capacity, cc	1984	2435	2319
Bore x Stroke, mm	81 x 77	83 x 90	81 x 90
Max. output ECE, bhp/kw/rpm	163/120/5100	200/147/5700	245/180/5400
Max. torque ECE, Nm/rpm	230/1800-5000	285/1800-5000	330/2400-5100
Octane rating	95-98 ⁽ⁱ⁾ RON unleaded	95-98 ⁽ⁱ⁾ RON unleaded	95-98 ⁽ⁱ⁾ RON unleaded
Fuel system	Multipoint Fuel Injection	Multipoint Fuel Injection	Multipoint Fuel Injection
Compression ratio	9.5:1	9.0:1	8.5:1

INSURANCE GROUPS	2.0T/2.0T GT	2.4T GT	T5 GT
Volvo C70 Convertible	15/16	17	18

WEIGHTS	All models
Min. kerb weight, kg (actual kerb weight dependent on spec.)	1565
Max. possible towing weight braked, kg	1600
Max. towing weight unbraked approx, kg ^(iv)	500
Max. total weight, kg	2020
Max. roof load, kg	N/A
Max. payload, kg (dependent on spec.)	455

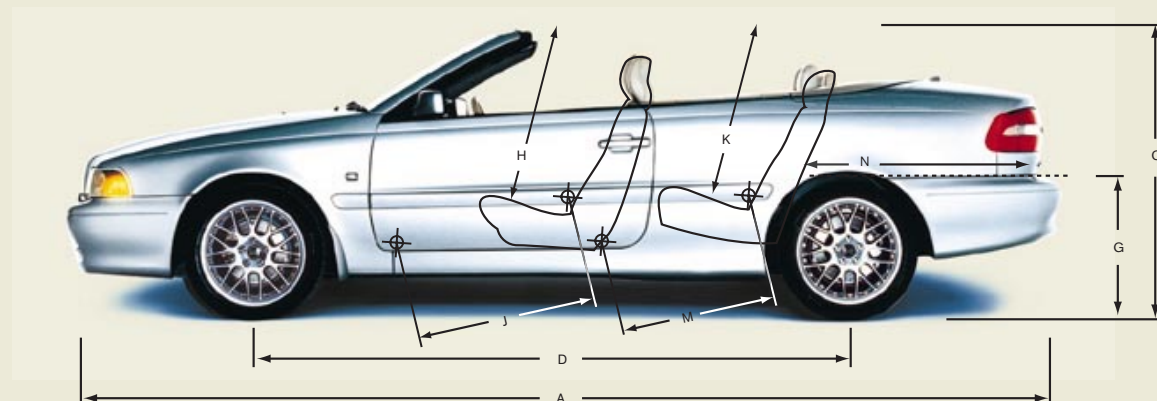

EXTERIOR (mm)		INTERIOR (mm)	
A Overall length	4716	H Front seat max. headroom	995
B Overall width (exc. wing mirrors)	1817	I Front seats width	1410
C Unladen height	1429	J Front seat max. legroom	1051
D Wheelbase length	2664	K Rear seat max. headroom	986
E Front track width	1521	L Rear seats width	1140
F Rear track width	1518	M Rear seat max. legroom	879
G Ground to boot base height	706	N Load length luggage 4 seat mode	820

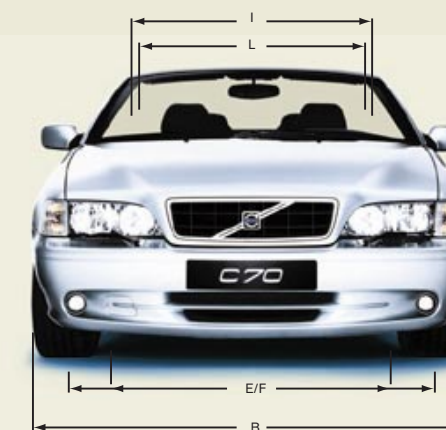

PERFORMANCE	2.0T Man	2.0T Auto	2.4T Man	2.4T Auto	T5 Man	T5 Auto
Top speed, mph	130	124	137	130	149	143
Acceleration 0-62mph, sec	9.9	10.7	8.5	9.0	7.5	8.0

TRANSMISSION	All models
Manual	5
Automatic	5

POWER STEERING SYSTEM	All models
(rack & pinion) Turning circle, m (ft)	11.7 (38'4")

FUEL CONSUMPTION ⁽ⁱⁱ⁾	2.0T Man	2.0T Auto	2.4T Man	2.4T Auto	T5 Man	T5 Auto
(Government Approved) Mpg (l/100km) ⁽ⁱⁱ⁾ Urban	20.9 (13.5)	18.1 (15.6)	20.6 (13.7)	17.7 (16.0)	20.6 (13.7)	17.7 (16.0)
Extra Urban	38.2 (7.4)	36.7 (7.7)	36.7 (7.7)	35.3 (8.0)	36.7 (7.7)	35.3 (8.0)
Combined	29.1 (9.7)	26.6 (10.6)	28.5 (9.9)	25.9 (10.9)	28.5 (9.9)	25.9 (10.9)
CO ₂ g/km	230	253	236	261	236	261
VED (Vehicle Excise Duty) Band	E	E	E	E	E	E

BRAKES	2.0/2.4T	T5
Disc diameter mm, front	280 Ventilated	302 Ventilated
Disc diameter mm, rear	295	295

LUGGAGE COMPARTMENT	All models
Volume, litres (cu.ft)	223 (8.1)

PERFORMANCE	All models
Drag co-efficient	0.34

FUEL TANK	All models
Volume, litres (gallons)	68 (15.0)

- (i) For best performance and lowest fuel consumption 98 RON is recommended. 95 RON can be used for normal driving.
- (ii) The Urban fuel consumption figure is based on typical city driving, including starting the car from cold. The Extra Urban figure is based on typical motorway driving and cruising. The Combined figure averages the consumption across both cycles.
- (iii) These results do not express or imply any guarantee of the fuel consumption of a particular car as there are inevitable differences between individual cars of the same model. Additionally driving style, traffic conditions, as well as the age and mileage and standard of maintenance will affect a car's fuel consumption.
- (iv) Unbraked towing weight must not exceed 50% of kerb weight up to a maximum of 750 kg.

Notes
 All weights for any specific vehicle will vary according to standard and optional equipment fitted. A weighbridge must be used to determine specific weights.
 Data valid for manual transmission unless specified.
 All measurements in mm.
 NB Some of the information in this price list may not be correct due to product changes which may have occurred since it was printed. Some of the equipment described or shown may now be available only at extra cost. Before ordering, please ask your Volvo dealer for the latest information. The manufacturer reserves the right to make changes at any time, without notice, to prices, colour, materials, specifications and models.
 Volvo Car UK Limited, Globe Park, Marlow, Buckinghamshire, SL7 1YQ



019
Black Stone



443
Moondust metallic



454
Ruby Red pearl



189
Polar White



451
Maya Yellow pearl



455
Titanium Grey pearl

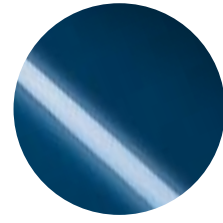

417
Nautic Blue pearl



452
Black Sapphire metallic



461
Sky Blue pearl

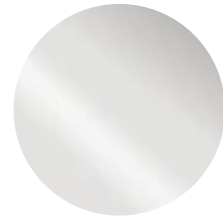

426
Silver metallic



612
Passion Red



Care by Volvo is a range of tailored benefits, facilities and services to make sure you get the maximum enjoyment from your Volvo.



FINANCE

CARE BY VOLVO

We make finance simple, clear and attractive. For private motorists, our flexible purchase schemes like Volvo Advantage make ownership affordable, with low monthly payments and low minimum deposit⁽ⁱ⁾. For business users, Volvo purchase plans, leasing and contract hire facilities offer tax efficient, versatile finance alternatives.

ASSISTANCE

CARE BY VOLVO

Every new car comes with one year's free RAC cover. You'll enjoy full breakdown and recovery assistance, anywhere in Europe, 24 hours a day. You can even extend cover for up to two more years at preferential rates.

OWNERS INSURANCE

CARE BY VOLVO

Statistics show Volvo drivers have fewer accidents. That means Volvo Owners insurance can offer competitive premiums with tailored protection and exclusive benefits. Operated in conjunction with The Royal and SunAlliance, one telephone call even deals with all arrangements for any claim.

WARRANTY

CARE BY VOLVO

Every new Volvo comes with comprehensive protection. Our warranty covers the first three years or 60,000 miles, whichever comes first. There's a three year unlimited warranty on the paintwork, and a full 8 years against rust perforation. If a component fails due to a defect or material fault, your dealer will swiftly rectify the problem, free of charge.

All 'On The Road' prices quoted in this price list include Volvo standard national delivery charge, inclusive of number plates, at £480 and the VED (Vehicle Excise Duty) car tax effective from 1st March 2000. The 'On The Road' price also includes a £25 vehicle first registration fee (as set by the government), effective since 1st April 1998 (excludes Channel Islands and Isle of Man). Retail prices quoted do not include these additions.

Details

The above is just an outline of the facilities available to Volvo Owners. For full details, contact your dealer.

⁽ⁱ⁾ Subject to status. Written quotations are available from Volvo Car Finance Limited, Globe Park, Marlow, Buckinghamshire SL7 1YQ.

VOLVO

Volvo Car UK Limited
www.volvocars.co.uk