



VOLVO V50



The V50 range at a glance.

V50 ES

The comprehensive standard specification includes ECC (Electronic Climate Control), 16" alloy wheels, DSTC (Dynamic Stability and Traction Control), roof rails, passenger airbag cut-off switch, power windows, information centre, a leather steering wheel and gear knob, floor mats, performance sound audio system with CD player and an Aux input for MP3 players.

V50 SE

The SE model brings added luxury. Textile/T-Tec upholstery, aluminium inlays, cruise control and steering wheel remote controls on the inside are complemented by 17" alloy wheels, autofolding power door mirrors with ground lights and fog lights on the outside.

V50 SE LUX

The most luxurious version of the Volvo V50 offers leather-faced upholstery, 17" Spartacus alloy wheels and active bending lights with headlight cleaning system.

V50 **R**DESIGN

The striking exterior lines are enhanced with 17" Cratus alloy wheels with full bodykit and logo on the grille. The unique interior design is complemented with embossed leather/T-Tec upholstery, sports steering wheel and unique aluminium inlay.

PREMIUM

The Premium model is the ultimate upgrade. The combination of leather-faced upholstery (leather/T-Tec on R-DESIGN), satellite navigation system and high performance audio system is designed to complement the existing high level of specification whichever model you choose.

V50 **DRIVE**

DRIVE is a series of modifications, adjustments and enhancements designed to make it easy to reduce both your impact on the environment and your running costs. All V50 DRIVE models come with Start/Stop technology to produce only 104 g/km CO₂ and fuel consumption up to 72.4 mpg*, which means £0 vehicle tax for the first year.

* Based on a combined cycle



On the road.

How much will it cost to get behind the wheel of your own Volvo V50? Simply decide which model variant and engine type are right for you and then take a look at the full price list below.

V50 ES

	Basic £	VAT @ 17.5% £	Rec Retail Price £	On the Road Price £
PETROL				
1.6 ES	£14,791.49	£2,588.51	£17,380.00	£18,220.00
DIESEL				
DRIVe (109 PS) ES Start/Stop	£17,408.51	£3,046.49	£20,455.00	£21,045.00
D2 (115 PS) ES	£17,408.51	£3,046.49	£20,455.00	£21,045.00
D3 (150 PS) ES ^(†)	£18,259.57	£3,195.43	£21,455.00	£22,155.00

V50 SE

	Basic £	VAT @ 17.5% £	Rec Retail Price £	On the Road Price £
PETROL				
2.0 SE	£17,302.13	£3,027.87	£20,330.00	£21,220.00
2.0 SE Premium ⁽ⁱ⁾	£18,876.60	£3,303.40	£22,180.00	£23,070.00
DIESEL				
DRIVe (109 PS) SE Start/Stop	£18,897.87	£3,307.13	£22,205.00	£22,795.00
D2 (115 PS) SE	£18,897.87	£3,307.13	£22,205.00	£22,795.00
D3 (150 PS) SE ^(†)	£19,748.94	£3,456.06	£23,205.00	£23,905.00
D3 (150 PS) SE Premium ^{(i)(†)}	£21,323.40	£3,731.60	£25,055.00	£25,755.00
D4 (177 PS) SE	£20,387.23	£3,567.77	£23,955.00	£24,655.00
D4 (177 PS) SE Premium ⁽ⁱ⁾	£21,961.70	£3,843.30	£25,805.00	£26,505.00

(†) Production commences end August 2010.

(i) All Premium models include leather-faced upholstery, satellite navigation system and high performance sound audio system.

(ii) All Premium models include satellite navigation system and high performance sound audio system.





V50 SE LUX

	Basic £	VAT @ 17.5% £	Rec Retail Price £	On the Road Price £
PETROL				
2.0 SE Lux	£18,365.96	£3,214.04	£21,580.00	£22,470.00
2.0 SE Lux Premium ⁽ⁱ⁾	£19,514.89	£3,415.11	£22,930.00	£23,820.00
DIESEL				
DRIVe (109 PS) SE Lux Start/Stop	£19,961.70	£3,493.30	£23,455.00	£24,045.00
D2 (115 PS) SE Lux	£19,961.70	£3,493.30	£23,455.00	£24,045.00
D3 (150 PS) SE Lux ^(†)	£20,812.77	£3,642.23	£24,455.00	£25,155.00
D3 (150 PS) SE Lux Premium ^{(i)(†)}	£21,961.70	£3,843.30	£25,805.00	£26,505.00
D4 (177 PS) SE Lux	£21,451.06	£3,753.94	£25,205.00	£25,905.00
D4 (177 PS) SE Lux Premium ⁽ⁱ⁾	£22,600.00	£3,955.00	£26,555.00	£27,255.00

V50 R-DESIGN

	Basic £	VAT @ 17.5% £	Rec Retail Price £	On the Road Price £
PETROL				
2.0 R-DESIGN	£17,514.89	£3,065.11	£20,580.00	£21,470.00
2.0 R-DESIGN Premium ⁽ⁱⁱⁱ⁾	£18,663.83	£3,266.17	£21,930.00	£22,820.00
T5 R-DESIGN Geartronic	£20,876.60	£3,653.40	£24,530.00	£25,670.00
T5 R-DESIGN Geartronic Premium ⁽ⁱⁱⁱ⁾	£22,025.53	£3,854.47	£25,880.00	£27,020.00
DIESEL				
D2 (115 PS) R-DESIGN	£19,110.64	£3,344.36	£22,455.00	£23,045.00
D3 (150 PS) R-DESIGN ^(†)	£19,961.70	£3,493.30	£23,455.00	£24,155.00
D3 (150 PS) R-DESIGN Premium ^{(iii)(†)}	£21,110.64	£3,694.36	£24,805.00	£25,505.00
D4 (177 PS) R-DESIGN	£20,600.00	£3,605.00	£24,205.00	£24,905.00
D4 (177 PS) R-DESIGN Premium ⁽ⁱⁱⁱ⁾	£21,748.94	£3,806.06	£25,555.00	£26,255.00











The right equipment.

It's essential that your Volvo comes equipped with everything you need. Below you'll find the standard equipment lists for each model variant, plus optional equipment to personalise your Volvo V50. And as you'd expect, there is an array of industry-leading, cutting edge safety innovations.

STANDARD EQUIPMENT - SAFETY & SECURITY	ES	SE	SE LUX	REDESIGN
Dual Stage Driver and Passenger Airbags	•	•	•	•
Passenger Airbag Cut Off Switch	•	•	•	•
SIPS (Side Impact Protection System)	•	•	•	•
SIPS Airbags	•	•	•	•
IC (Inflatable Curtains)	•	•	•	•
WHIPS (Whiplash Protection System) (Front Seats)	•	•	•	•
ABS (Anti-lock Brake System) with EBD (Electronic Brake Distribution) and Electronic Brake Assistance	•	•	•	•
DSTC (Dynamic Stability and Traction Control)	•	•	•	•
5 Three Point Seat Belts	•	•	•	•
Seat Belt Pre-tensioners (Front and Outer Rear)	•	•	•	•
Head Restraints - All 5 Seats	•	•	•	•
ISOFIX Attachment (Rear Seats)	•	•	•	•
Anti-theft Alarm including Immobiliser and Level Sensor	•	•	•	•
Key Integrated Remote Control Central Locking including Fuel Flap with Deadlocking System	•	•	•	•
Auto Open/Close Power Windows/and Sunroof (if ordered)	•	•	•	•
Tinted Windscreen	•	•	•	•
Load Cover and Load Protection Net	•	•	•	•
Visible VIN Plate	•	•	•	•
Day Running Lights	•	•	•	•
Headlight Levelling System	•	•	•	•
High Level LED Brake Light	•	•	•	•
Side Marker Illumination	•	•	•	•
Home Safe and Approach Lighting	•	•	•	•
IDIS (Intelligent Driver Information System)	•	•	•	•
Warning Triangle	•	•	•	•

STANDARD EQUIPMENT - EXTERIOR	ES	SE	SE LUX	REDESIGN
16" Libra Alloy Wheels (Diamond Cut) - 205/55 R16 V Energy Saving Tyres (DRIVE only)	•			
16" Cordelia Alloy Wheels (Silver Stone) - 205/55 R16 W Tyres	•			
17" Serapis Alloy Wheels (Silver Bright) - 205/50 R17 W Tyres		•		
17" Spartacus Alloy Wheels (Silver Bright) - 205/50 R17 W Tyres			•	
17" Cratus Alloy Wheels (Silver Bright) - 205/50 R17 W Tyres				•
Locking Wheel Nuts	•	•	•	•
Tyre Sealant Kit	•	•	•	•
Active Bending Lights with Headlight Cleaning System			•	
Autofolding Power Door Mirrors with Ground Lights		•	•	
Power Adjustable and Heated Door Mirrors	•	•	•	•
Front Fog Lights		•	•	•
REDESIGN Silver Matt Door Mirrors				•
Speed Dependent Interval Wiper Function	•	•	•	•
REDESIGN Silver Matt Grille with Logo				•
Rain Sensor - Automatic Windscreen Wiper Activation		•	•	
Roof Rails	•	•		•
Silver Roof Rails			•	
Comfort Chassis (1.6 and 2.0 only)	•	•	•	•
Dynamic Chassis (T5, D3 and D4 only)	•	•	•	•
DRIVE Lowered Chassis (DRIVE and D2 only)	•	•	•	•
REDESIGN Full Bodykit (Front and Rear Spoilers and Side Skirts)				•
Colour Co-ordinated Lower Mouldings	•	•	•	

STANDARD EQUIPMENT - INTERIOR

	ES	SE	SE LUX	
ECC (Electronic Climate Control) and Pollen Filter	•	•	•	•
Information Centre	•	•	•	•
Exterior Temperature Gauge	•	•	•	•
Cruise Control		•	•	•
Front and Rear Power Windows	•	•	•	•
Illuminated Driver and Passenger Vanity Mirrors	•	•	•	•
Front and Rear Reading Lights	•	•	•	•
Autodimming Rear View Mirror with Humidity Sensor		•	•	
Front Centre Armrest	•	•	•	•
Rear Centre Armrest with Twin Cupholders and Storage		•	•	
Front Storage Box with Removable Cupholders	•	•	•	•
12 V Socket (Front and Rear)	•	•	•	•
Height Adjustable Passenger Seat with Lumbar Support		•	•	
Forward Folding Front Passenger Seat	•	•	•	•
Asymmetric Split-folding Rear Seat (60%/40%)	•	•	•	•
Leather Steering Wheel, Gear Knob and Handbrake Lever	•	•	•	
 Leather Sports Steering Wheel with Aluminium Inserts and Logo				•
 Sports Gear Knob with Aluminium Inserts and Leather Handbrake Lever				•
Steering Wheel Remote Audio Controls		•	•	•
Watch Dials		•	•	
 Blue Instrument Dials				•
Height and Reach Adjustable Steering Column	•	•	•	•
Bauxite Trim	•			
Aluminium Trim		•	•	
 Deco Aluminium Trim				•
Boda Textile Upholstery	•			
Dalarö T-Tec Upholstery		•		
Leather-faced Upholstery (Standard on SE Premium and SE Lux models only)		•	•	
 Leather/T-Tec Upholstery with Logo				•
Floor Mats	•	•	•	
 Sports Floor Mats with Contrasting Piping				•
 Aluminium Sports Pedals				•
Performance Sound Audio System – 1 x CD/Radio, 4 x 20 W Amplifier and 6 Speakers	•	•	•	•
High Performance Sound Audio System – 1 x CD/Radio, 4 x 40 W Amplifier, USB and 8 Speakers (MP3/WMA Compatible) (Standard on Premium models only)		•	•	•
Aux Input for MP3 Player	•	•	•	•



OPTIONAL EQUIPMENT – SAFETY & SECURITY	Basic £	VAT @ 17.5% £	Rec Retail Price £	ES	SE	SE LUX	R-DESIGN
BLIS (Blind Spot Information System) with Autofolding Power Door Mirrors and Ground Lights. See “SPECIAL OFFER” .	£553.19	£96.81	£650.00	o	u (£450)	u (£450)	o
Laminated Water Repellent Side Windows	£357.45	£62.55	£420.00	o	o	o	o

“SPECIAL OFFER” – Purchase BLIS and receive a free Family Pack.

OPTIONAL EQUIPMENT – INTERIOR	Basic £	VAT @ 17.5% £	Rec Retail Price £	ES	SE	SE LUX	R-DESIGN
Geartronic Automatic Transmission (D3 and D4) (Standard T5)	£1,234.04	£215.96	£1,450.00	o	o	o	o
Cruise Control	£225.53	£39.47	£265.00	o	•	•	•
Keyless Drive	£297.87	£52.13	£350.00	o	o	o	o
Power Glass Tilt and Slide Sunroof	£506.38	£88.62	£595.00	o	o	o	o
Autodimming Rear View Mirror with Humidity Sensor	£170.21	£29.79	£200.00	n/a	•	•	o
Grocery Bag Holder ^(vii)	£68.09	£11.91	£80.00	o	o	o	o
Front and Rear Ashtray with Cigarette Lighter	–	–	–	nco	nco	nco	nco
Rear Centre Armrest with Twin Cupholders and Storage	£63.83	£11.17	£75.00	o	•	•	o
Power Driver Seat with Memory for Seat	£480.85	£84.15	£565.00	o	o	o	o
Power Driver Seat and Power Passenger Seat with Memory for Driver Seat	£961.70	£168.30	£1,130.00	o	o	o	o
Height Adjustable Passenger Seat with Lumbar Support	£89.36	£15.64	£105.00	o	•	•	o
Heated Front Seat	£225.53	£39.47	£265.00	o	o	o	o
Aluminium Trim	£221.28	£38.72	£260.00	o	•	•	n/a
Oyster Burst Trim	£221.28	£38.72	£260.00	o	nco	nco	n/a
Nordic Light Oak Trim	£221.28	£38.72	£260.00	n/a	o	o	n/a
Leather-faced Upholstery (Standard on SE Premium models)	£1,063.83	£186.17	£1,250.00	o	u (£650)	•	n/a
6 x CD Player ⁽ⁱ⁾⁽ⁱⁱ⁾	£85.11	£14.89	£100.00	o	o	o	o
High Performance Sound Audio System – 1 x CD/Radio, 4 x 40 W Amplifier, USB and Aux Input and 8 Speakers (MP3/WMA Compatible) (Standard on Premium models)	£340.43	£59.57	£400.00	o	o	o	o
Premium Sound Audio System – with Dolby Pro Logic II Surround Sound ⁽ⁱⁱⁱ⁾ , 5 x 130 W Amplifier, USB and Aux Input, 1 x CD and 12 Speakers (MP3/WMA Compatible)	£851.06	£148.94	£1,000.00	o	o	o	o
Steering Wheel Remote Audio Controls	£68.09	£11.91	£80.00	o	•	•	•
Satellite Navigation System with RDS-TMC and Map Data on Hard Disk ⁽ⁱ⁾ (Standard on Premium models)	£1,276.60	£223.40	£1,500.00	o	o	o	o
Bluetooth® Handsfree System ^(iv)	£225.53	£39.47	£265.00	o	o	o	o
Dual Band Integrated GSM Telephone and Volvo On Call ^{(i)(v)}	£438.30	£76.70	£515.00	o	o	o	o
Air Quality System	£85.11	£14.89	£100.00	o	o	o	o

• = standard, o = option, n/a = not available, nco = no cost option, u (£) = upgrade ® = Registered Trademark.

(i) Must be ordered in conjunction with High Performance or Premium Sound Audio Systems.

(ii) If a 6 x CD Player is ordered, standard USB port is removed from the audio system.

(iii) Dolby and Pro Logic Surround Sound™ are trademarks of Dolby Laboratories Licensing Corporation.





OPTIONAL EQUIPMENT - EXTERIOR	Basic £	VAT @ 17.5% £	Rec Retail Price £	ES	SE	SE LUX	RDESIGN
Black Paint (Solid)	£225.53	£39.47	£265.00	o	o	o	n/a
Metallic Paint	£468.09	£81.91	£550.00	o	o	o	o
Inscription™ Paint	£659.57	£115.43	£775.00	o	o	o	o
16" Libra Alloy Wheels (Diamond Cut) - 205/55 R16 V Energy Saving Tyres (DRIVE only)	-	-	-	●	nco	nco	n/a
16" Cordelia Alloy Wheels (Silver Stone) – 205/55 R16 W Tyre ^(vi)	-	-	-	●	nco	nco	n/a
16" Convector Alloy Wheels (Silver Stone) – 205/55 R16 W Tyres ^(vi)	-	-	-	nco	nco	nco	n/a
17" Zaurak Alloy Wheels (Diamond Cut/Dark Grey) – 205/50 R17 W Tyres	£446.81	£78.19	£525.00	o	nco	nco	n/a
17" Spartacus Alloy Wheels (Silver Bright) – 205/50 R17 W Tyres	£446.81	£78.19	£525.00	o	nco	●	n/a
18" Atreus Alloy Wheels (Diamond Cut/Dark Grey) – 215/45 R18 W Tyres (Not 1.6 or D2)	£659.57	£115.43	£775.00	n/a	n/a	n/a	o
18" Midir Alloy Wheels (Diamond Cut/Light Grey) – 215/45 R18 W Tyres (Not 1.6 or D2)	£659.57	£115.43	£775.00	n/a	n/a	n/a	o
Tempa Spare Wheel and Jack Kit ^(vii)	-	-	-	nco	nco	nco	nco
Autofolding Power Door Mirrors with Ground Lights	£170.21	£29.79	£200.00	o	●	●	o
Front Fog Lights	£170.21	£29.79	£200.00	o	●	●	●
Rear Park Assist	£319.15	£55.85	£375.00	o	o	o	o

	Basic £	VAT @ 17.5% £	Rec Retail Price £	ES	SE	SE LUX	RDESIGN
WINTER PACK							
Heated Front Seats and Headlight Cleaning System	£319.15	£55.85	£375.00	o	o	n/a	o
Winter Pack with Active Bending Lights	£851.06	£148.94	£1,000.00	o	o	n/a	o
FAMILY PACK							
Integrated Booster Cushions x 2 and Power Child Locks. See "SPECIAL OFFER"	£200.00	£35.00	£235.00	o	o	o	o
RDESIGN CONVENIENCE PACK							
Autodimming Rear View Mirror with Humidity Sensor, Autofolding Power Door Mirrors with Ground Lights, Rain Sensor, Rear Armrest with Cupholders and Height Adjustable Passenger Seat with Lumbar Support	£446.81	£78.19	£525.00	n/a	n/a	n/a	o

(iv) Bluetooth® Handsfree System must be ordered in conjunction with Steering Wheel Remote Audio Controls on ES. Aux Input is removed when Bluetooth® Handsfree System is ordered in conjunction with Performance Sound Audio System. For details of compatibility, please go to: www.volvocars.com/Bluetooth

(v) Volvo On Call includes Safety package (Security package available at additional cost).

(vi) If ordered with DRIVE model, energy saving tyres will be fitted.

(vii) Tempa Spare Wheel cannot be combined with Grocery Bag Holder on D4 models.

Inside information.

Here you can learn more about the features and technology of your New Volvo V50. Some are standard, some are optional. For more detailed information, please contact your Volvo dealer or visit www.volvocars.co.uk

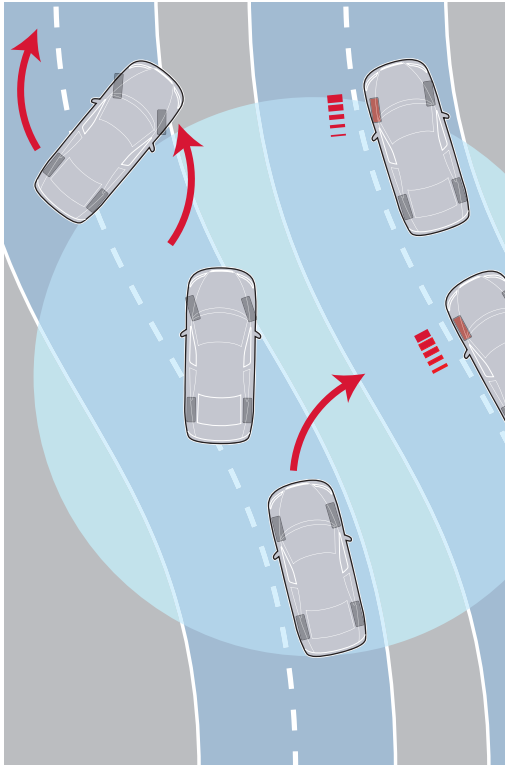

Dynamic Stability and Traction Control (DSTC)

By helping prevent fishtails, spinouts, and rollovers, stability control technology like DSTC has been described as one of the most vital safety advances of the past decade. At the core of DSTC, a gyroscope senses the car's direction and compares this with steering wheel movements as well as the actual rotation of the car's wheels. DSTC is able to detect a potential skid and help counteract this by reducing the engine's power output, or braking on one or more wheels.

Whiplash Protection System (WHIPS)

Integrated in the front seats, Volvo's WHIPS cradles the occupant to help reduce the risk of whiplash injury (one of the most common types of traffic injury and often the result of a low-speed rear impact collision). The function is activated by a collision of sufficient force from behind. Independent research has shown that WHIPS is one of the most effective systems in the world and can reduce the risk of long-term injuries by 50%.



Side Impact Protection System (SIPS)

SIPS is a Volvo unique safety system that has been developed to help protect where occupants are most exposed to the crash forces. The steel framework of the car – including the front seats – is designed and reinforced to help displace the impact of a side collision away from the occupants to other parts of the car body and help prevent intrusion into the cabin. The side structure is extremely strong to help withstand a severe side impact – even with a larger vehicle. The Inflatable Curtains (IC) for all the outboard occupants and the front seat side airbags interact to help provide further protection.



ISOFIX

ISOFIX attachments only allow you to fit the child seat in the correct way. They also make the child seat easier to fit and remove. We offer two rear-facing child seats with ISOFIX attachments: one for infants and small children up to 13 kg, and one for children weighing between 9 and 18 kg.



Dual-stage airbags, driver and front passenger

Helping to optimise protection, the dual-stage airbags adapt the level of inflation depending on the force of the collision. The driver's airbag also interacts with the deformation of the collapsible steering column.



Inflatable Curtains (IC)

The Inflatable Curtains (IC) protect the heads of both front and rear outboard occupants. They also stay inflated for some seconds to provide prolonged protection for subsequent impacts.



Satellite Navigation System

Volvo's GPS-based satellite navigation system is totally integrated with your car. It offers both voice guidance and graphic navigation all the way to your destination. Via TMC (Traffic Message Channel) radio data broadcasts it also lets you know if there's weather related trouble en-route and recommends an alternative. This system is easily controlled from the steering wheel or a remote, and the screen is positioned so you can keep your attention on traffic. When not in use, the screen retracts into the dash. The maps are on one DVD and cover major parts of Europe. To help you keep track of new roads and points of interest, you can join our MapCare programme for two free map updates.

Autofolding Power Door Mirror with Ground Lights

At the touch of a button, these door mirrors can be folded flat against the car where they are less likely to get damaged after you've parked. They also fold or unfold automatically every time you lock or unlock the car. The integrated ground lighting is activated with the remote control. Beyond enhancing security to and from your car at night, this is also convenient when getting in and out.



Integrated Bluetooth® Handsfree System

Bluetooth® technology enables a mobile phone to be connected to the infotainment system in your Volvo, wirelessly. Once configured for a mobile phone, the system automatically recognises your phone as you enter the car. And as you climb in and out of the car, the system automatically allows you to switch freely from the phone to the handsfree system and back again. With Volvo's integrated Bluetooth® handsfree system you conveniently operate your phone using the buttons in the steering wheel or the centre console keypad. Available as an accessory, there's also a voice-controlled Bluetooth® handsfree system that will listen to your command and make calls for you.

The Bluetooth word mark and logos are owned by the Bluetooth SIG, Inc. and any use of such marks by Volvo Car Corporation is under licence. Other trademarks and trade names are those of their respective owners.

For details of compatibility, please go to: www.volvocars.com/Bluetooth

Blind Spot Information System (BLIS)

BLIS uses rear-facing cameras installed in the door mirrors to keep a lookout on either side of the car. As a vehicle enters your blind spot, this function can alert you with a lamp built into the front door post – left or right. Together with the door mirrors, this helps you assess the feasibility of a lane change. BLIS is activated once the car exceeds 6 mph, and reacts to almost any type of vehicle from a motorcycle upwards, day or night.

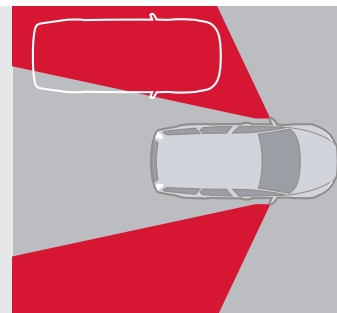

Keyless Drive

Keep the car key in your pocket or handbag. Using the keyless drive technology you can unlock the doors and drive away without using the car key. To start the engine, just turn the starter control in the instrument panel.

Park Assist

Activated when you engage reverse gear, rear park assist helps you when reversing into tight spaces. The audio system is turned down and a pulsating sound from the rear loudspeakers becomes a continuous tone as you approach an obstacle.

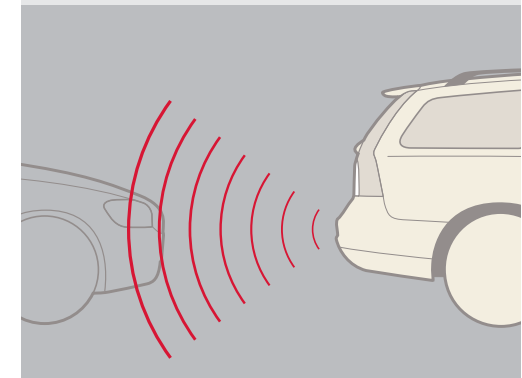

Accessories from Volvo.

Of course, your Volvo V50 won't be perfect until it's exactly how you want it. So here's a selection of our range of accessories to completely personalise your new car.



Towbar-mounted bike rack

This state-of-the-art holder secures your bicycles conveniently and safely on the back of your Volvo.



'Space Design' roof box

A lightweight, aerodynamic roof box available in two sizes: 380 and 480 litres.



Frame-mounted bicycle holder

This holder secures the bicycle at the frame and both wheels and fits most frame sizes.



Infant seat (up to 13kg)

Infants can travel safely backwards in this comfortable, easy-to-carry seat with five-point harness.



18" Medea
Silver Bright



17" Zaurak
Silver Bright



USB and iPod® Music Interface*

Simply connect your iPod® or USB device and seamlessly integrate with your Volvo's audio system.



Convertible child seat (9-25 kg)

Advanced design helps provide world-class protection and flexible seating for many years.



Portable navigation system

Designed to complement your Volvo, this easy-to-use Garmin nüvi® navigation unit guides you all the way.



Booster seat (15-36 kg)

Volvo's new booster seat helps position a child at the correct height for the safety belt.



Sports pedals

Enhance the driving experience with these tough, ridged sports pedals.



Towbars

Our lockable, easy-to-remove towbars are designed specifically for your Volvo.

Take a look at all our accessories and full pricing information at www.volvocars.co.uk/accessories

COLOUR YOUR VOLVO. When it comes to the appearance of your Volvo, the choice of exterior colour and wheels are probably your most important design decisions. For more exterior styling options and to build your new Volvo online, please visit www.volvocars.co.uk



019 Black Stone



426 Silver metallic ⁽¹⁾



452 Black Sapphire metallic ⁽¹⁾



455 Titanium Grey metallic ⁽¹⁾



466 Barents Blue metallic ⁽¹⁾



477 Inscription™ Electric Silver coarse flake metallic ⁽¹⁾
(sparkling metallic, shifts from silver to blue effect depending on light)



481 Cosmic White metallic



490 Chameleon Blue metallic
(shifts from blue to gold or transparent effect depending on light)

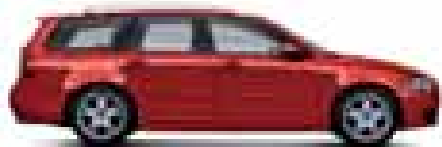

612 Passion Red ⁽¹⁾



614 Ice White ⁽¹⁾



701 Orange Flame metallic



702 Flamenco Red metallic

⁽¹⁾ Also available on the V50 R-DESIGN.

⁽²⁾ Exclusive on the V50 R-DESIGN.

Please note: It is not possible to reproduce exact original shades in printed matter. Please ask your dealer to show you samples.

Clean colours

To reduce usage of environmentally hazardous solvents all Volvo exterior colours are water-based. What's more, our painting facilities are among the cleanest in the world.

EXTERIOR DESIGN Aluminium wheels



18" Atrius
Diamond Cut/Dark Grey



18" Midir
Diamond Cut/Light Grey



17" Cratus
Silver Bright Matt



17" Serapis
Silver Bright



17" Spartacus
Silver Bright



17" Zaurak
Diamond Cut/Dark Grey



16" Convector
Silver Stone



16" Cordelia
Silver Stone



16" Libra
Diamond Cut

Please note: All wheels cannot be combined with all engine variants.
Please talk to your Volvo dealer for more information.

IMAGINE YOUR NEW INTERIOR. Crafted according to your requirements, the interior of your Volvo can take on any number of personalities. Choose between two interior colours, Off Black and Dark Umbra, and different upholstery variants. Pick the interior that suits you and add the finishing touch with the interior trim, steering wheel, gear knob and floor mat of your choice. After all, you're probably going to spend a lot of time here.



ERGONOMIC DESIGN Developed in co-operation with ergonomic specialists to provide generous support for the body during hours of driving, the seats in the Volvo V50 are among the most comfortable in the automotive world. Multiple adjustment possibilities and adjustable lumbar support make it easy to find the perfect driving position.



Leather-faced

This is the upholstery that affords the Volvo V50 an atmosphere of luxury. It's a new hide quality that's smooth, durable and has a fine grain pattern. Like all Volvo leather-faced upholsteries, it's organically tanned and ages beautifully.



Dalarö T-Tec

This contemporary textile upholstery trimmed with ultra-modern T-Tec, inspired by wetsuits and durable outdoor gear. The ribbed backrest and contrasting seams add further zest.



Boda textile

This textile upholstery with colour coordinated piping reflects the sporty yet relaxed elegance of the Volvo V50.

INTERIOR DESIGN



Leather steering wheel



Leather gear knob,
manual



Leather gear knob,
Geartronic



R-DESIGN Leather sports steering wheel
with aluminium inlay



R-DESIGN Leather gear knob with aluminium
inlay, manual, and a sports gaiter



R-DESIGN Leather gear knob with aluminium
inlay, Geartronic

INTERIOR DESIGN



Off Black textile mats



Quartz textile mats



Bauxite centre stack
and door panel inlays

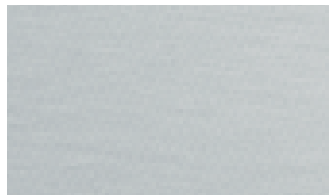

Aluminium centre stack
and door panel inlays



Nordic Light Oak centre stack
and door panel inlays



Oyster Burst centre stack
and door panel inlays

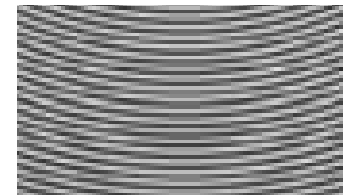

R-DESIGN centre stack
and door panel inlays

Upholstery	Upholstery code	Upholstery colour	Dashboard top & upper door panel	Lower door panel, lower dashboard, carpet & tunnel console	Floor mats	Door insert colour	Headliner colour
R-DESIGN Leather/ T-Tec with Logo	5F7K	Off Black/Cream	Off Black	Off Black	Off Black/Cream	Off Black	Quartz Beige
Leather-faced	5D77	Off Black	Off Black	Off Black	Off Black	Off Black	Quartz Beige
	5DE4	Calcite Cream	Dark Umbra	Quartz Beige	Quartz Beige	Calcite Cream	Quartz Beige
	5DFT	Off Black/Calcite Cream	Off Black	Off Black	Off Black	Calcite Cream	Quartz Beige
	5DF4	Calcite Cream	Off Black	Off Black	Off Black	Calcite Cream	Quartz Beige
Dalarö T-Tec	5CE1	Quartz Beige	Dark Umbra	Quartz Beige	Quartz Beige	Quartz Beige	Quartz Beige
	5C77	Off Black	Off Black	Off Black	Off Black	Off Black	Quartz Beige
Boda textile	5BE1	Quartz Beige	Dark Umbra	Quartz Beige	Quartz Beige	Quartz Beige	Quartz Beige
	5B77	Off Black	Off Black	Off Black	Off Black	Off Black	Quartz Beige

INTERIOR DESIGN Leather-faced



Off Black interior
Leather-faced Off Black 5D77



Off Black interior
Leather-faced Off Black/Calcite Cream with Orange contrast stitching 5DFT



Off Black interior
Leather-faced Calcite Cream 5DF4



Dark Beige interior
Leather-faced Calcite Cream 5DE4

INTERIOR DESIGN Dalarö T-Tec



Off Black interior
Dalarö T-Tec Off Black 5C77

INTERIOR DESIGN Boda textile



Off Black interior
Boda textile Off Black 5B77



Dark Beige interior
Dalarö T-Tec Quartz Beige 5CE1



Dark Beige interior
Boda textile Quartz Beige 5BE1

Please note: It's not possible to reproduce exact original shades in printed matter.
Please ask your dealer to show you samples.



In fine detail.

The nuts and bolts of your Volvo V50. Whatever you need to know about your new car – whether that's fuel consumption, CO₂ emissions, top speed or boot space – you'll find it here.

ENGINE	1.6 Man	2.0 Man	T5 Auto	DRIVE Man	D2	D3	D4
Configuration/Cylinders	Transverse – 16 valve 4 cylinder	Transverse – 16 valve 4 cylinder	Transverse – 20 valve 5 cylinder	Transverse – 16 valve 4 cylinder	Transverse – 8 valve 4 cylinder	Transverse – 20 valve 5 cylinder	Transverse – 20 valve 5 cylinder
Engine capacity, cc	1596	1999	2521	1560	1560	1984	1984
Max. output ECE, PS/kw/rpm	100/74/6000	145/107/6000	230/169/5000	109/80/4000	115/84/3600	150/110/3500	177/130/3500
Max. torque ECE, Nm/rpm	150/4000	185/4500	320/1500 – 5000	240/1750	270/1750	350/1500 – 2750	400/1750 – 2750
Fuel	95 RON Unleaded	95 RON Unleaded	98 RON ^(b) Unleaded	Diesel	Diesel	Diesel	Diesel
Fuel system	Multipoint fuel injection	Multipoint fuel injection	Multipoint fuel injection	Common rail direct injection	Common rail direct injection	Common rail direct injection	Common rail direct injection
Fuel tank volume, litres (gallons)	55 (12.1)	55 (12.1)	62 (13.6)	52 (11.4)	52 (11.4)	60 (13.2)	60 (13.2)

PERFORMANCE	1.6 Man	2.0 Man	T5 Auto	DRIVE Man	D2 Man	D3 Man	D3 Auto	D4 Man	D4 Auto
Top speed, mph	115	130	146	118	121	130	127	137	134
Acceleration 0-60mph, sec	11.4	9.0	6.8	10.9	10.9	9.0	9.1	8.3	8.4
0-62mph (0-100kmh), sec	12.0	9.6	7.3	11.5	11.5	9.6	9.7	8.8	8.9
Drag co-efficient	0.31	0.31	0.31	0.29	0.31	0.31		0.31	

FUEL CONSUMPTION ^{(b)(iii)} (Government Approved)	1.6 Man	2.0 Man	T5 Auto	DRIVE Man	D2 Man	D3 Man	D3 Auto	D4 Man	D4 Auto
Mpg / l/100 km									
Urban	30.7/9.2	26.2/10.8	20.9/13.5	57.7/4.9	54.3/5.2	40.4/7.0	35.8/7.9	40.4/7.0	35.8/7.9
Extra Urban	48.7/5.8	49.6/5.7	43.5/6.5	83.1/3.4	74.3/3.8	70.6/4.0	61.4/4.6	70.6/4.0	61.4/4.6
Combined	39.8/7.1	37.2/7.6	31.4/9.0	72.4/3.9	65.7/4.3	55.4/5.1	48.7/5.8	55.4/5.1	48.7/5.8

EMISSIONS	1.6 Man	2.0 Man	T5 Auto	DRIVE Man	D2 Man	D3 Man	D3 Auto	D4 Man	D4 Auto
CO ₂ g/km	169	176	211	104	114	134	154	134	154
Vehicle Tax Band	H	I	K	B	C	E	G	E	G
First Year Vehicle Tax £	£250.00	£300.00	£550.00	£0.00	£0.00	£110.00	£155.00	£110.00	£155.00
Subsequent Years Vehicle Tax £	£180.00	£200.00	£245.00	£20.00	£30.00	£110.00	£155.00	£110.00	£155.00
Emission Level	Euro IV	Euro V	Euro V	Euro IV	Euro V	Euro V		Euro V	

NB All diesel models are fitted with a Diesel Particulate Filter.

LUGGAGE COMPARTMENT	All models
Volume (rear seats up - luggage area) litres (cu.ft)	417
Volume (rear seats down) litres (cu.ft)	717

TRANSMISSION	
Manual D2 (115 PS)/D3 (150 PS)/D4 (177 PS)	6 speed
Manual 1.6/2.0/DRIVE	5 speed
Geartronic (Automatic Gearbox) D3 (150 PS)/D4 (177 PS)	6 speed
Geartronic (Automatic Gearbox) T5	5 speed

INSURANCE RATINGS
Insurance ratings may vary depending on model line and specification. For insurance ratings, please refer to http://www.thatcham.org/abigrouprating

WEIGHTS	1.6 Man	2.0 Man	T5 Auto	DRIVE Man	D2 Man	Man D3	Auto D3	Man D4	Auto D4
Min. kerb weight, kg (actual kerb weight dependent on spec.)	1338	1400	1524	1427	1400	1521	1537	1537	1552
Max. possible towing weight braked, kg	1200	1350	1500	1300	1300	1500	1500	1500	1500
Max. towing weight unbraked approx, kg ^(iv)	650	700	700	650	650	700	700	700	700
Max. towball weight, kg	75	75	75	75	TBC	TBC	TBC	TBC	TBC
Max. total weight, kg	1850	1890	2000	1900	1900	2020	2020	2020	2020
Max. roof load, kg	75	75	75	75	75	75	75	75	75
Max. payload, kg (dependent on spec.)	512	490	476	473	500	499	483	483	468

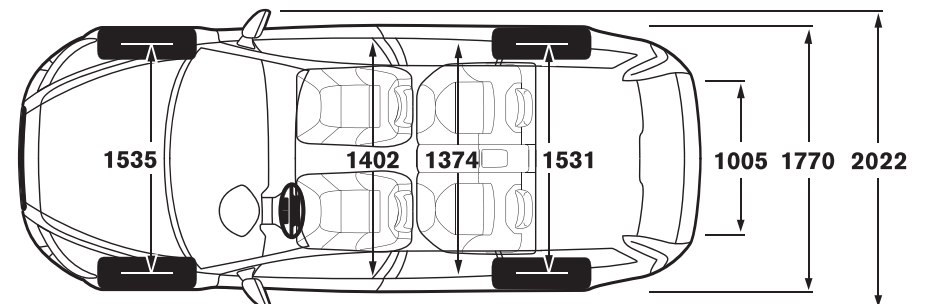
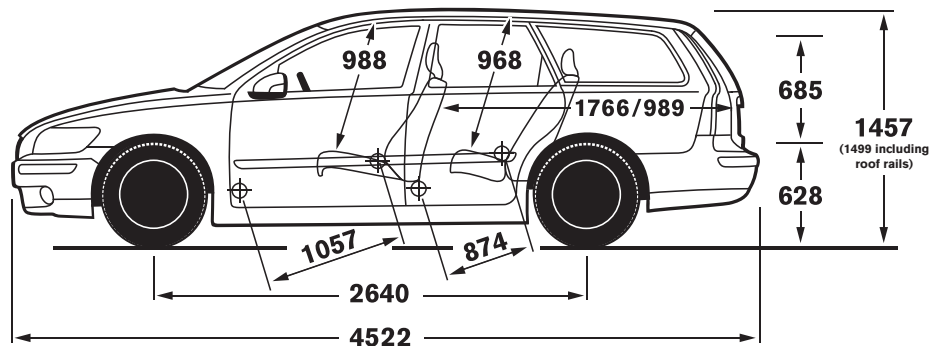

- (i) For best performance and lowest fuel consumption 98 RON is recommended, 95 RON can be used for normal driving.
- (ii) These results do not express or imply any guarantee of the fuel consumption of a particular car.
- (iii) Official fuel consumption figures are obtained in accordance with Directive 93/116/EC as amended by 1999/100/EC. The figures are obtained under controlled test conditions and as such consumption achieved on the road will not necessarily accord with the official test results. Factors including driving styles and road, car and weather conditions will also have a bearing on actual fuel consumption achieved.
- (iv) Unbraked towing weight must not exceed 50% of kerb weight up to a maximum of 700 kg.

Notes

The weight of the vehicle will influence the level of CO₂ emitted and as a result, vehicles with higher levels of specification and factory fit options may emit higher levels of CO₂. However, Vehicle Excise Duty is charged according to the weight and CO₂ emissions of the standard vehicle, as published in this price list. The weight effect of any additional items does not affect the amount of Vehicle Excise Duty payable.

A weighbridge must be used to determine specific weights. Data valid for manual transmission unless specified.

All measurements in mm.

Auto = Geartronic Automatic Transmission.

The max. output figures are quoted in PS (Pferdestärke), which is the metric equivalent of brake horsepower.

NB Some of the information in this price list may not be correct due to product changes which may have occurred since it was printed. Some of the equipment described or shown may now be available only at extra cost. Before ordering, please ask your Volvo dealer for the latest information. The manufacturer reserves the right to make changes at any time, without notice, to prices, colour, materials, specifications and models.

Volvo Car UK Limited, Globe Park, Marlow, Buckinghamshire, SL7 1YQ.

Meet the family.

Please note: Some of the information in this brochure may be incorrect due to changes in product specification that may have occurred since printing. Some of the equipment described or shown may now only be available at extra cost. Before ordering, please ask your Volvo dealer for the latest information. The manufacturer reserves the right to make changes at any time and without notice, to prices, colours, materials, specifications and models.

Furthermore: There are options, accessories and packages that can be chosen separately or combined as you like. For more information, please contact your Volvo dealer.

S



Volvo S40 The compact and energetic saloon.



The all-new Volvo S60 The sleek and sporty saloon, created to thrill.



Volvo S80 The premier saloon, meticulously engineered for superior driving comfort.

V



Volvo V50 The Sportswagon — flexible, compact and full of zest.



Volvo V70 The genuine family estate — highly competitive yet comfortably versatile.

XC



Volvo XC60 A sporty coupe and a capable all-roader fused into a Swedish crossover experience.

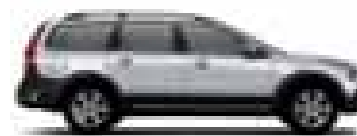

Volvo XC70 The rugged yet stylish all-roader.



Volvo XC90 The versatile SUV that takes you anywhere with grace.

C



The new Volvo C30 The compact and charismatic SportsCoupe.



The new Volvo C70 A retractable hardtop convertible that seats four adults with comfort.



The end is just the beginning.

VOLVO TOTAL CARE

We want your experience of buying and owning a Volvo to be one of life's pleasures, that's why we're here to make it as care-free and easy as possible. It's simple – Volvo Total Care is a single port of call for all your motoring requirements, from funding your purchase to protecting your investment with Volvo Car Insurance to monthly payment plans for servicing. We will even provide you with special offers during your ownership. Volvo Total Care is designed to make owning a Volvo rewarding. For further information on Volvo Total Care please contact your dealer or go to www.volvocars.co.uk/totalcare

FINANCE

Volvo Car Financial Services have developed a series of funding plans that will provide you with a range of choices and flexibility when acquiring a Volvo®. For details of the current promotions available, please visit www.volvocars.co.uk/financepromotions

WHAT NEXT? If you'd like to find out more about the range of products and services that make up Care by Volvo, the story continues at www.volvocars.co.uk. Alternatively you can contact your nearest Volvo dealer or request relevant brochures.

- (i) Finance subject to status. Terms and conditions apply. Guarantees/Indemnities may be required. Applicants must be 18 or over. Volvo Car Financial Services RH1 1SR.
- (ii) When using a Volvo approved Body and Paint repairer.
- (iii) Volvo Car Insurance is underwritten by Royal & Sun Alliance Insurance plc (No. 93792). Registered in England and Wales at St Mark's Court, Chart Way, Horsham, West Sussex RH12 1XL. Authorised and regulated by the Financial Services Authority. For your protection telephone calls will be recorded and may be monitored. All benefits are subject to qualifying status, terms and conditions, cover level and underwriting criteria. Service and repair benefits are subject to being carried out by a recommended repairer.

INSURANCE

Volvo Car Insurance is designed for Volvo drivers and because we know Volvos inside out, we can offer exactly the right tools and expertise, fitting only genuine Volvo parts by trained Volvo technicians[®]. Your Volvo will come with seven days drive away insurance, so you've already got peace of mind. Because Volvo drivers have an excellent reputation, we can also offer extensive cover at a reasonable price[®]. Call now for your insurance quote on **0800 238 239**, quoting reference BROCH.

SERVICING YOUR VOLVO

Your Volvo dealer has the unique know-how to tailor a service programme according to Volvo's strict recommendations and guarantees you years of safety and driving pleasure. In addition, why not save yourself money on service costs by taking out a Volvo Service Plan? They're designed to spread servicing costs on an interest-free monthly basis, providing you with economic, convenient servicing and peace of mind.

Whatever option you choose your costs are fixed no matter what happens to labour, parts or oil prices. You will also have the satisfaction of being able to have your Volvo serviced at any one of our UK Volvo dealers and Service Centres. For further information and to purchase online please go to www.volvocars.co.uk/serviceplan

VOLVO ON CALL

Subscribe to Volvo On Call and you'll never be completely on your own. It's a GPS-based communication system providing 24-hour access to both emergency and roadside assistance wherever you are. See the Volvo On Call brochure for more information.

LOOKING AHEAD

You'll probably never find out just how good some of these services are. But should the unexpected happen, we'd like to think that you'd be even happier you chose a Volvo.

ROADSIDE ASSISTANCE

Every new car comes with one year's Volvo Assistance cover. You'll enjoy free breakdown and recovery assistance, anywhere in Europe, 24 hours a day. You can even extend cover for £85 for one year or £125 for two years. Call Volvo Assistance on **0845 641 9747**.

WARRANTY

Every new Volvo comes with comprehensive protection. Our warranty covers the first three years or 60,000 miles, whichever comes first. There's a three year unlimited mileage warranty on the paintwork, and either eight or twelve years against rust perforation. If a component fails due to a defect or material fault, your dealer will swiftly rectify the problem, free of charge.

THERE'S MORE TO LIFE THAN A VOLVO.

Volvo. for life



THAT'S WHY YOU DRIVE ONE.

VOLVO

Volvo Car UK Limited
www.volvocars.co.uk

All "On The Road" prices quoted in this price list include Volvo standard national delivery charge, inclusive of number plates and VAT at £535 and the VED (Vehicle Excise Duty) car tax as of 1st April 2010 (as set by the government). This charge does not include any provision for fuel. The "On The Road" price also includes a £55 vehicle first registration fee (as set by the government – excludes Channel Islands and Isle of Man). Recommended retail prices quoted do not include these additions.

MODEL YEAR 2011 EDITION 1
Issued 01/04/2010