

VOLVO C30

PRICE AND SPECIFICATION







Create your perfect Volvo C30

Congratulations. You're only a few steps away from your perfect Volvo C30. This price list contains everything you need to create the car that's exactly right for you.

From selecting the right package and choosing from a range of class leading engines, through to picking the perfect colour and adding the finishing touches, you're in complete control. You'll also find full engine details and in-depth technical specifications to help you make the most informed choice.

Whatever you decide, you'll be choosing a car that dares to be different. A dynamic, four-seater SportsCoupe, the Volvo C30 boasts dramatic and expressive exterior style coupled with an innovative interior.





C30 *R*DESIGN SPORT

The striking exterior lines are enhanced with 17" Serapis alloy wheels with full bodykit and logo on the grille. The unique interior design is complemented with embossed Leather/T-Tec upholstery, sports steering wheel and unique aluminium inlay.

C30 *R*DESIGN SE SPORT

This model combines the luxury features of the SE with the unique R-DESIGN interior details and the dramatic exterior sporty bodykit and 18" Atreus alloy wheels.

C30 S

The comprehensive standard specification includes ECC (Electronic Climate Control), 16" alloy wheels, DSTC (Dynamic Stability and Traction Control), power windows, a leather steering wheel and gear knob, a CD player and an Aux input for MP3 players.

C30 SE

The SE model brings added luxury. Kalix Textile/T-Tec upholstery, aluminium inlays, cruise control and steering wheel remote controls on the inside are complemented by the 17" Mestra alloy wheels and fog lights on the outside.

C30 SE LUX

The most luxurious version of the Volvo C30 offers leather upholstery, heated front seats and luxury floor mats, whilst 17" Spartacus alloy wheels, autofolding power door mirrors with ground lights and a headlamp cleaning system identify this model from the outside.

C30 *DRIVE*

DRIVE is a series of modifications, adjustments and enhancements designed to make it easy to reduce both your impact on the environment and your running costs. The Volvo C30 1.6D DRIVE produces only 115 g/km of CO₂ – which means 12 months' car tax of just £35. Its fuel consumption is up to 64.2 mpg*, and it comes with the choice of S, SE and SE Lux trim levels – so there's no compromise on style or luxury. See page 18 for more information.

* Based on a combined cycle

On the road

How much will it cost to get behind the wheel of your own Volvo C30? Simply decide which model variant and engine type are right for you and then take a look at the full price list below.

C30 R-DESIGN SPORT

	Basic £	VAT £	Rec Retail Price £	On the Road Price £
PETROL				
1.6 R-DESIGN Sport	£12,391.30	£1,858.70	£14,250.00	£14,995.00
1.8 R-DESIGN Sport	£13,260.87	£1,989.13	£15,250.00	£15,995.00
2.0 R-DESIGN Sport	£14,130.43	£2,119.57	£16,250.00	£16,995.00
T5 R-DESIGN Sport	£16,739.13	£2,510.87	£19,250.00	£20,035.00
DIESEL				
1.6D R-DESIGN Sport	£13,813.04	£2,071.96	£15,885.00	£16,580.00
2.0D R-DESIGN Sport	£15,117.39	£2,267.61	£17,385.00	£18,105.00
D5 R-DESIGN Sport	£16,421.74	£2,463.26	£18,885.00	£19,605.00
FLEXIFUEL				
1.8F R-DESIGN Sport	£13,521.74	£2,028.26	£15,550.00	£16,295.00

C30 R-DESIGN SE SPORT

	Basic £	VAT £	Rec Retail Price £	On the Road Price £
PETROL				
1.8 R-DESIGN SE Sport	£14,130.43	£2,119.57	£16,250.00	£16,995.00
2.0 R-DESIGN SE Sport	£15,000.00	£2,250.00	£17,250.00	£17,995.00
T5 R-DESIGN SE Sport	£17,608.70	£2,641.30	£20,250.00	£21,035.00
DIESEL				
2.0D R-DESIGN SE Sport	£15,986.96	£2,398.04	£18,385.00	£19,105.00
D5 R-DESIGN SE Sport	£17,291.30	£2,593.70	£19,885.00	£20,605.00





C30 S

	Basic £	VAT £	Rec Retail Price £	On the Road Price £
DIESEL				
1.6D DRIVe S	£12,726.09	£1,908.91	£14,635.00	£15,245.00

C30 SE

	Basic £	VAT £	Rec Retail Price £	On the Road Price £
PETROL				
1.6 SE	£12,391.30	£1,858.70	£14,250.00	£14,995.00
1.8 SE	£13,260.87	£1,989.13	£15,250.00	£15,995.00
2.0 SE	£14,130.43	£2,119.57	£16,250.00	£16,995.00
DIESEL				
1.6D DRIVe SE	£14,030.43	£2,104.57	£16,135.00	£16,745.00
2.0D SE	£15,117.39	£2,267.61	£17,385.00	£18,105.00
D5 SE	£16,421.74	£2,463.26	£18,885.00	£19,605.00
FLEXIFUEL				
1.8F SE	£13,521.74	£2,028.26	£15,550.00	£16,295.00

C30 SE LUX

	Basic £	VAT £	Rec Retail Price £	On the Road Price £
PETROL				
1.8 SE Lux	£14,565.22	£2,184.78	£16,750.00	£17,495.00
2.0 SE Lux	£15,434.78	£2,315.22	£17,750.00	£18,495.00
DIESEL				
1.6D DRIVe SE Lux	£15,334.78	£2,300.22	£17,635.00	£18,245.00
2.0D SE Lux	£16,421.74	£2,463.26	£18,885.00	£19,605.00
D5 SE Lux	£17,726.09	£2,658.91	£20,385.00	£21,105.00

The right equipment

It's essential that your Volvo comes equipped with everything you need. Below you'll find the standard equipment lists for each model variant, plus optional equipment to personalise your Volvo C30. And as you'd expect, there is an array of industry-leading, cutting edge safety innovations.

	R-DESIGN SPORT	R-DESIGN SE SPORT	S	SE	SE LUX
STANDARD EQUIPMENT - SAFETY & SECURITY					
Dual Stage Driver and Passenger Airbags	•	•	•	•	•
SIPS (Side Impact Protection System)	•	•	•	•	•
SIPS Airbags	•	•	•	•	•
IC (Inflatable Curtain)	•	•	•	•	•
WHIPS (Whiplash Protection System)	•	•	•	•	•
ABS (Anti-lock Brake System) with EBD (Electronic Brake Distribution) and Electronic Brake Assistance	•	•	•	•	•
DSTC (Dynamic Stability and Traction Control)	•	•	•	•	•
4 Three Point Seat Belts	•	•	•	•	•
Seat Belt Pre-tensioners (Front and Rear)	•	•	•	•	•
Head Restraints - All 4 Seats	•	•	•	•	•
ISOFIX Attachment - Rear Seats	•	•	•	•	•
Anti-theft Alarm including Immobiliser and Level Sensor	•	•	•	•	•
Key Integrated Remote Control Central Locking including Fuel Flap with Deadlocking System	•	•	•	•	•
Auto Open/Close Windows/Sunroof	•	•	•	•	•
Tinted Windows	•	•	•	•	•
Hard Load Cover	•	•	•	•	•
Visible VIN Plate	•	•	•	•	•
Day Running Lights	•	•	•	•	•
Headlamp Levelling System	•	•	•	•	•
High Level LED Brake Light	•	•	•	•	•
Side Marker Illumination	•	•	•	•	•
Home Safe and Approach Lighting	•	•	•	•	•
IDIS (Intelligent Driver Information System)	•	•	•	•	•

	R-DESIGN SPORT	R-DESIGN SE SPORT	S	SE	SE LUX
STANDARD EQUIPMENT - EXTERIOR					
16" Libra Alloy Wheels (Diamond Cut) - 205/55 R16 V Energy Saving Tyres			•		
17" Mestra Alloy Wheels (Silver Bright) - 205/50 R17 W Tyres				•	
17" Spartacus Alloy Wheels (Silver Bright) - 205/50 R17 W Tyres					•
17" Serapis Alloy Wheels (Silver Bright) - 205/50 R17 W Tyres	•				
18" Atrius Alloy Wheels (Diamond Cut/Dark Grey) - 215/45 R18 W Tyres		•			
Locking Wheel Nuts	•	•	•	•	•
Tyre Sealant Kit and Compressor	•	•	•	•	•
Headlamp Cleaning System					•
Autofolding Power Door Mirrors with Ground Lights					•
Power Adjustable and Heated Door Mirrors	•	•	•	•	•
Front Fog Lights	•	•			•
Colour Coordinated Door Mirrors				•	•
R-DESIGN Silver Matt Door Mirrors	•	•			
R-DESIGN Silver Matt Grille with Logo	•	•			
Rain Sensor - Automatic Windscreen Wiper Activation		•		•	•
Dynamic Chassis	•	•		•	•
DRIVE Lowered Chassis (1.6D DRIVE only)			•	•	•
Rear Spoiler (D5, T5, R-DESIGN Sport and R-DESIGN SE Sport Models)	•	•		•	•
Full Bodykit® with Unique Tail Pipe	•	•			
Unique DRIVE features (Tailgate Spoiler, Lower Rear Bumper Diffuser, Flat Underbody Panels, Partly Covered Grille, Energy Saving Tyres (16" only) and Unique DRIVE Emblem) (1.6D DRIVE only)			•	•	•



STANDARD EQUIPMENT - INTERIOR	RDESIGN SPORT	RDESIGN SE SPORT	S	SE	SE LUX
ECC (Electronic Climate Control) with AQS (Air Quality System) and Pollen Filter	•	•	•	•	•
Information Centre		•		•	•
Exterior Temperature Gauge	•	•	•	•	•
Cruise Control	•	•		•	•
Front Power Windows	•	•	•	•	•
Illuminated Driver and Passenger Vanity Mirrors	•	•	•	•	•
Front Reading Lights	•	•	•	•	•
Autodimming Rear View Mirror with Humidity Sensor and Compass		•		•	•
Front and Rear Centre Armrest	•	•	•	•	•
Front Storage Box with Removable Cupholders	•		•	•	•
Bottle Holder		•		•	•
Rear 12V Socket	•	•	•	•	•
Power Driver's Seat with Seat Memory					•
Heated Front Seats					•
Height Adjustable Passenger Seat with Lumbar Support	•	•	•	•	•
Folding Rear Seats	•	•	•	•	•
Leather Steering Wheel, Gear Knob and Handbrake Lever			•	•	•
RDESIGN Leather Sports Steering Wheel with Aluminium Inserts and Logo	•	•			
RDESIGN Sports Gear Knob with Aluminium Inserts and Leather Handbrake Lever	•	•			
Steering Wheel Remote Audio Controls	•	•		•	•
RDESIGN Blue Instrument Dials	•	•			
Height and Reach Adjustable Steering Column	•	•	•	•	•
RDESIGN Sports Floor Mats with Contrasting Piping	•	•			
RDESIGN Aluminium Sports Pedals	•	•			
Bauxite Trim			•		
Aluminium Trim				•	•
RDESIGN Deco Aluminium Trim	•	•			
Falsterbo Upholstery			•		
Kalix Textile/T-Tec Upholstery				•	
Leather-faced Upholstery					•
RDESIGN Leather/T-Tec Upholstery with Logo	•	•			
Luxury Floor Mats					•
Performance Sound Audio System – 1 x CD/Radio, 4 x 20W Amplifier and 6 Speakers	•	•	•	•	•
Aux Input for MP3 Player	•	•	•	•	•

(i) Please check with dealer for colour availability.



OPTIONAL EQUIPMENT - SAFETY & SECURITY	Basic £	VAT £	Rec Retail Price £	REDESIGN SPORT	REDESIGN SE SPORT	S	SE	SE LUX
BLIS (Blind Spot Information System) with Autofolding Power								
Door Mirrors and Ground Lights	£565.22	£84.78	£650.00	o	o	o	o	u (£450)
Passenger Airbag Cut Off Switch	£21.74	£3.26	£25.00	o	o	o	o	o
Laminated Side Windows	£260.87	£39.13	£300.00	o	o	o	o	o
Homelink	£43.48	£6.52	£50.00	o	o	o	o	o
Soft Load Cover	-	-	-	nco	nco	nco	nco	nco

OPTIONAL EQUIPMENT - EXTERIOR	Basic £	VAT £	Rec Retail Price £	REDESIGN SPORT	REDESIGN SE SPORT	S	SE	SE LUX
Black Paint (Solid)	£217.39	£32.61	£250.00	n/a	n/a	o	o	o
Metallic/Pearlescent Paint	£456.52	£68.48	£525.00	o	o	o	o	o
Inscription™ Paint	£652.17	£97.83	£750.00	o	o	o	o	o
16" Libra Alloy Wheels (Diamond Cut) – 205/55 R16 V Energy Saving Tyres (1.6D DRiVe only)	-	-	-	n/a	n/a	●	nco	nco
16" Celeus Alloy Wheels (Silver Stone) – 205/55 R16 V Energy Saving Tyres	-	-	-	n/a	n/a	nco	n/a	n/a
16" Ceryx Alloy Wheels (Silver Stone) – 205/55 R16 V Energy Saving Tyres	-	-	-	n/a	n/a	nco	n/a	n/a
16" Cordelia Alloy Wheels (Silver Stone) – 205/55 R16 V Energy Saving Tyres	-	-	-	n/a	n/a	nco	n/a	n/a
17" Mestra Alloy Wheels (Silver Bright) – 205/55 R16 W Tyres	£260.87	£39.13	£300.00	n/a	n/a	o	●	nco
17" Spartacus Alloy Wheels (Silver Bright) – 205/50 R17 W Tyres	£260.87	£39.13	£300.00	n/a	n/a	o	nco	●
17" Zaurak Alloy Wheels (Chromed) – 205/50 R17 W Tyres	£695.65	£104.35	£800.00	n/a	n/a	o	u (£500)	u (£200)
18" Atrous Alloy Wheels (Diamond Cut/Dark Grey) – 215/45 R18 W Tyres (Not 1.6)	£434.78	£65.22	£500.00	o	●	n/a	n/a	n/a
18" Midir Alloy Wheels (Diamond Cut/Light Grey) – 215/45 R18 W Tyres (Not 1.6)	£434.78	£65.22	£500.00	o	nco	n/a	n/a	n/a
Tempa Spare Wheel	-	-	-	nco	nco	nco	nco	nco
Front Fog Lights	£156.52	£23.48	£180.00	●	●	o	●	●
Autofolding Power Door Mirrors with Ground Lights	£173.91	£26.09	£200.00	o	o	o	o	●
Rear Park Assist	£304.35	£45.65	£350.00	o	o	o	o	o





OPTIONAL EQUIPMENT - INTERIOR	Basic £	VAT £	Rec Retail Price £	R-DESIGN SPORT	R-DESIGN SE SPORT	S	SE	SE LUX
Powershift (6 Speed Automatic Transmission) (2.0D only)	£1,217.39	£182.61	£1,400.00	o	o	n/a	o	o
Geartronic Transmission (T5 and D5 only)	£1,086.96	£163.04	£1,250.00	o	o	n/a	o	o
Information Centre	£165.22	£24.78	£190.00	o	●	o	●	●
Keyless Drive	£304.35	£45.65	£350.00	o	o	o	o	o
Power Glass Tilt and Slide Sunroof	£608.70	£91.30	£700.00	o	o	o	o	o
Autodimming Rear View Mirror with Humidity Sensor and Compass	£217.39	£32.61	£250.00	o	●	o	●	●
Power Driver's Seat with Seat Memory	£478.26	£71.74	£550.00	o	o	o	o	●
Aluminium Trim	£217.39	£32.61	£250.00	n/a	n/a	o	●	●
Virtual White Trim	£217.39	£32.61	£250.00	n/a	n/a	o	nco	nco
Kalix Textile/T-Tec Upholstery	£521.74	£78.26	£600.00	n/a	n/a	o	●	n/a
Leather-faced Upholstery ⁽ⁱ⁾	£1,043.48	£156.52	£1,200.00	u (£500)	u (£500)	o	u (£600)	●
Steering Wheel Remote Audio Controls	£52.17	£7.83	£60.00	●	●	o	●	●
6 x CD Player ⁽ⁱⁱ⁾⁽ⁱⁱⁱ⁾	-	-	-	nco	nco	nco	nco	nco
High Performance Sound Audio System – 1 x CD/Radio, 4 x 40W Amplifier, USB and Aux Input and 8 Speakers (MP3/WMA Compatible)	£260.87	£39.13	£300.00	o	o	o	o	o
Dynaudio Premium Sound Audio System – with Dolby Pro Logic II Surround Sound ^(iv) , 5 x 130W Amplifier, USB and Aux Input, 1 x CD and 10 Speakers (MP3/WMA Compatible)	£1,000.00	£150.00	£1,150.00	o	o	o	o	o
Satellite Navigation System (RTI) with RDS-TMC and Map Data on Hard Disk ^(v)	£1,304.35	£195.65	£1,500.00	o	o	o	o	o
Bluetooth® Handsfree System ^(vi)	£217.39	£32.61	£250.00	o	o	o	o	o
Dual Band Integrated GSM Telephone ^(vi) and Volvo On Call ^(vii)	£434.78	£65.22	£500.00	o	o	o	o	o

	Basic £	VAT £	Rec Retail Price £	R-DESIGN SPORT	R-DESIGN SE SPORT	S	SE	SE LUX
WINTER PACK								
Heated Front Seats, Headlamp Cleaning System and Luxury Floor Mats	£347.83	£52.17	£400.00	u (£325)	u (£325)	o	o	●
Winter Pack with Dual Xenon Headlamps	£739.13	£110.87	£850.00	u (£775)	u (£775)	o	o	u (£450)
COMMUNICATIONS PACK								
Satellite Navigation System (RTI) with RDS-TMC ⁽ⁱⁱ⁾ , Remote Control and Map Data on Hard Disk, Keyless Drive and Bluetooth® Handsfree System ^{(vi)(vii)}	£1,521.74	£228.26	£1,750.00	o	o	o	o	o

- = standard, o = option, n/a = not available, nco = no cost option, u (£) = upgrade, ® = Registered Trademark.
- (i) Leather-faced Upholstery upgrade on R-DESIGN Sport and R-DESIGN SE Sport is only available with 5D77 Off Black.
- (ii) Must be ordered in conjunction with High Performance or Dynaudio Premium Sound Audio Systems.
- (iii) If a 6 x CD Player is ordered, standard USB port is removed from the audio system.
- (iv) Dolby and Pro Logic Surround Sound™ are trademarks of Dolby Laboratories Licensing Corporation.
- (v) Aux Input is removed when Bluetooth® Handsfree System is ordered in conjunction with Performance Sound Audio System.
- (vi) Volvo On Call includes Safety package (Security package available at additional cost).
- (vii) Cannot be ordered in conjunction with Dual Band Integrated Telephone and Volvo On Call.



What's your style?

At Volvo we know everyone is different. And that's why you can choose from a whole spectrum of colours for the exterior of your Volvo C30. Whatever your style, you'll find the perfect shade for you.



019 Black Stone[®]



426 Silver metallic



452 Black Sapphire metallic



455 Titanium Grey pearl



466 Barents Blue pearl



476 Brilliant Blue pearl



477 Inscription™ Electric Silver
Coarse Flake metallic

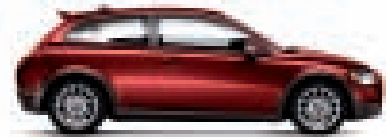

478 Maple Red pearl[®]



479 Orinoco Blue metallic



481 Cosmic White metallic



488 Gecko Green pearl



489 Matt Gold pearl[®]



490 Chameleon Blue pearl[®]



492 Savile Grey pearl[®]



612 Passion Red



614 Ice White

The R-DESIGN Sport and R-DESIGN SE Sport bodykits are colour coordinated with the exception of 481 Cosmic White metallic which is combined with a Java Pearl bodykit.
NB It is not possible to reproduce exact original shades in printed matter. Please ask your Volvo dealer to show you samples.
(i) Not available with R-DESIGN Sport and R-DESIGN SE Sport.

The wheels

And now we come to one of the most important parts of choosing your new Volvo C30. Volvo alloy wheels come in a variety of different styles, cuts and finishes – each with its own distinct character.

Your selection of alloy wheel can dramatically influence the exterior styling of your Volvo C30. What will you choose?





16" Libra
(Diamond Cut)



16" Celeus
(Silver Stone)



16" Ceryx
(Silver Stone)



16" Cordelia
(Silver Stone)

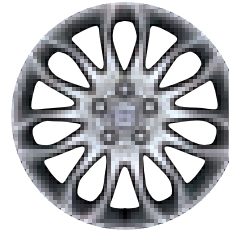

17" Mestra
(Silver Bright)

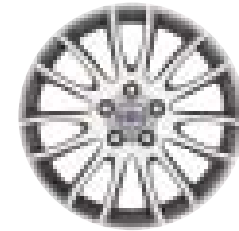

17" Spartacus
(Silver Bright)



17" Zaurak
(Chromed)



17" Serapis
(Silver Bright)



18" Atreus
(Diamond Cut/Dark Grey)



18" Midir
(Diamond Cut/Light Grey)

Interior inlays

A selection of premium materials to complement your interior fabric.

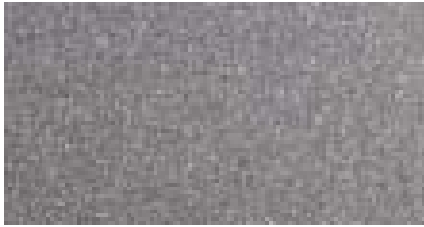

Bauxite

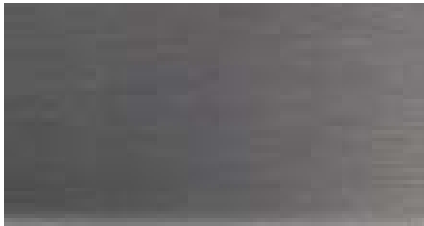

Aluminium

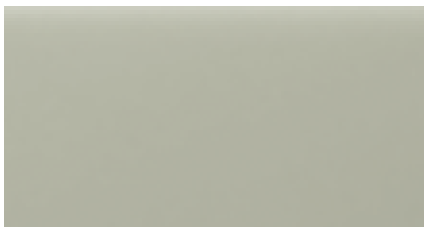

Virtual White

NB It is not possible to reproduce exact original shades in printed matter.





Bespoke tailoring from Volvo

The finest fabrics, superb stitching and minute attention to detail – whichever interior you choose for your Volvo C30 you'll be surrounded by luxury. How will you tailor yours?

FALSTERBO



Off Black (5777)

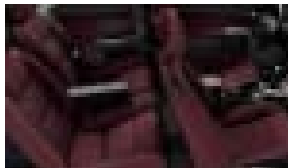

Red (5779)



Blue (577A)

KALIX TEXTILE/T-TEC



Off Black (5A77)



Off Black/Quartz Beige with Quartz Beige Carpets (5AFC)



Off Black with Red Carpets (5AB7)



Off Black with Quartz Beige Carpets (5AC7)



Off Black/Quartz Beige with Off Black Carpets (5A7C)

LEATHER-FACED



Off Black (5D77)

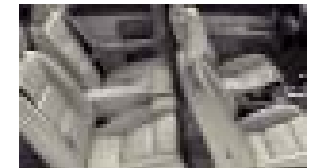

Calcite Cream (5DC4)



Quartz Beige (5DE1)

UPHOLSTERY	Upholstery Code	Upholstery Colour	Dashboard Top and Upper Door Panel	Lower Dashboard, Lower Door Panel and Tunnel Console	Base Carpets	Floor Mats	Door Insert Colour	Headliner Colour
Falsterbo	5777	Off Black	Off Black	Off Black	Off Black	Off Black	Off Black	Quartz Beige
	5779	Red	Off Black	Off Black	Off Black	Off Black	Red	Quartz Beige
	577A	Blue	Off Black	Off Black	Off Black	Off Black	Blue	Quartz Beige
Kalix Textile/T-Tec	5A77	Off Black	Off Black	Off Black	Off Black	Off Black	Off Black	Quartz Beige
	5AC7	Off Black	Off Black	Quartz Beige	Quartz Beige	Quartz Beige	Off Black	Quartz Beige
	5AB7	Off Black	Off Black	Off Black	Off Black	Red	Off Black	Quartz Beige
	5AFC	Off Black/Quartz Beige	Off Black	Off Black	Quartz Beige	Quartz Beige	Off Black	Quartz Beige
	5A7C	Off Black/Quartz Beige	Off Black	Off Black	Off Black	Off Black	Off Black	Quartz Beige
R DESIGN Leather/T-Tec with Logo	5F7K	Off Black/Cream	Off Black	Off Black	Off Black	Off Black/Cream	Off Black	Quartz Beige
Leather-faced	5D77	Off Black	Off Black	Off Black	Off Black	Off Black	Off Black	Quartz Beige
	5DE1	Quartz Beige	Dark Umbra	Quartz Beige	Quartz Beige	Quartz Beige	Quartz Beige	Quartz Beige
	5DC4	Calcite Cream	Off Black	Quartz Beige	Quartz Beige	Quartz Beige	Calcite Cream	Quartz Beige

R DESIGN

Like to drive a car that turns heads? Then choose a Volvo C30 R-DESIGN. With a range of striking style flourishes both inside and out, this is a car that can't fail to be noticed.

R-DESIGN



Steering Wheel and Blue Dials



Front Grille with Logo



Silver Matt Door Mirrors



Pedals

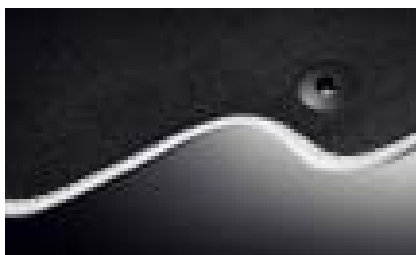

Floor Mats

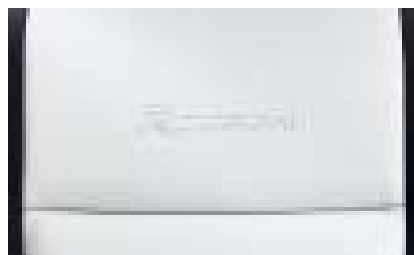

Off Black/Cream (5F7K)

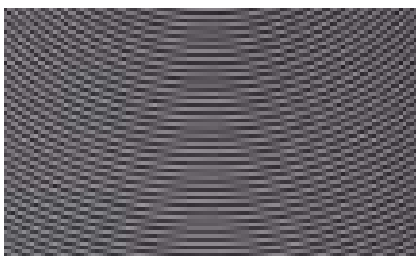

R DESIGN Deco Aluminium





DRIVE

DRIVE means making a change for the better without compromise. The exterior styling is unmistakably Volvo, with strong curves and sleek lines – yet DRIVE enhancements like the lowered chassis, Libra alloy wheels and rear spoiler add distinctive finishing touches. And these changes aren't just for show – they contribute to CO₂ emissions of just 115 g/km and fuel economy of up to 64.2 mpg*.

Better fuel consumption and emissions with all the style, luxury and technology you've come to expect – who said it wasn't easy to do the right thing?

* Based on a combined cycle

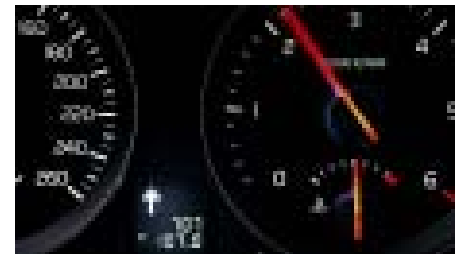
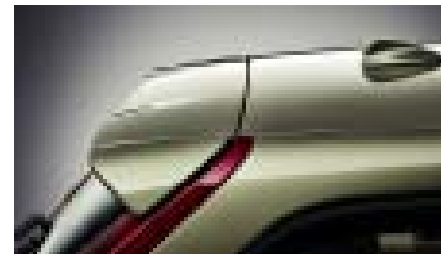

16" Libra
(Diamond Cut)



In fine detail

The nuts and bolts of your Volvo C30. Whatever you need to know about your new car – whether that's fuel consumption, CO₂ emissions, top speed or boot space – you'll find it here.

ENGINE	1.6 Man	1.8 Man	2.0 Man	T5	1.6D Man	1.6D DRIVe Man	2.0D	D5	1.8F Flexifuel Man
Configuration	Transverse – 16 valve	Transverse – 16 valve	Transverse – 16 valve	Transverse – 20 valve	Transverse – 16 valve	Transverse – 16 valve	Transverse – 16 valve	Transverse – 20 valve	Transverse – 16 valve
Cylinders	4	4	4	5	4	4	4	5	4
Engine capacity, cc	1596	1798	1999	2521	1560	1560	1997	2400	1798
Bore x stroke, mm	79 x 81.4	83 x 83.1	87.5 x 83.1	83 x 93.2	75 x 88.3	75 x 88.3	85 x 88	81 x 93.2	83 x 83.1
Max. output ECE, PS/kw/rpm	100/74/6000	125/92/6000	145/107/6000	230/169/5000	109/80/4000	109/80/4000	136/100/4000	180/132/4000	125/92/6000
Max. torque ECE, Nm/rpm	150/4000	165/4000	185/4500	320/1500 – 5000	240/1750	240/1750	320/2000	400/2000 – 2750	165/4000
Octane rating	95 RON Unleaded	95 RON Unleaded	95 RON Unleaded	98 RON ⁽⁹⁾ Unleaded	N/A Diesel	N/A Diesel	N/A Diesel	N/A Diesel	95 RON Unleaded/ Bio-ethanol (E85)
Fuel system	Multipoint fuel injection	Multipoint fuel injection	Multipoint fuel injection	Multipoint fuel injection	Multipoint direct fuel injection	Multipoint direct fuel injection	Multipoint direct fuel injection	Multipoint direct fuel injection	Multipoint fuel injection
Compression ratio	11.0:1	10.8:1	10.8:1	9.0:1	18.3:1	18.3:1	18.5:1	17.3:1	10.8:1

PERFORMANCE	1.6 Man	1.8 Man	2.0 Man	T5 Man	T5 Gt	1.6D Man	1.6D DRIVe Man	2.0D Man	2.0D P/shift	D5 Man	D5 Gt	1.8F Flexifuel Man
Top speed (mph)	115	124	130	149	146	118	118	127	127	140	137	124
Acceleration 0-60mph, sec	11.2	10.2	8.8	6.2	6.6	10.7	10.7	8.8	9.0	7.3	7.8	10.2
Acceleration 0-62mph (0-100kmh), sec	11.8	10.8	9.4	6.7	7.1	11.3	11.3	9.4	9.5	7.7	8.4	10.8
Drag co-efficient	0.31	0.31	0.31	0.31	0.31	0.31	0.28	0.31	0.31	0.31	0.31	0.31

FUEL CONSUMPTION ⁽¹⁰⁾⁽¹¹⁾	1.6 Man	1.8 Man	2.0 Man	T5 Man	T5 Gt	1.6D Man	1.6D DRIVe Man	2.0D Man	2.0D P/shift	D5 Man	D5 Gt	1.8F Flexifuel Man ⁽¹²⁾
Urban mpg (l/100km)	30.4 (9.3)	28.0 (10.1)	27.7 (10.2)	22.6 (12.5)	20.0 (14.1)	45.6 (6.2)	50.4 (5.6)	37.2 (7.6)	37.2 (7.6)	34.0 (8.3)	29.7 (9.5)	28.0 (10.1)
Extra Urban mpg (l/100km)	49.6 (5.7)	48.7 (5.8)	48.7 (5.8)	43.5 (6.5)	42.2 (6.7)	67.3 (4.2)	78.5 (3.6)	61.4 (4.6)	57.6 (4.9)	56.5 (5.0)	52.3 (5.4)	49.6 (5.7)
Combined mpg (l/100km)	40.4 (7.0)	38.7 (7.3)	38.2 (7.4)	32.5 (8.7)	30.1 (9.4)	57.6 (4.9)	64.2 (4.4)	49.6 (5.7)	47.9 (5.9)	45.6 (6.2)	40.9 (6.9)	38.7 (7.3)
CO ₂ g/km	167	174	177	208	224	129	115	151	156	164	182	174
VED (Vehicle Excise Duty) Band	E	E	E	F	F	C	B	D	D	D	E	E
Fuel tank volume, litres	55	55	55	62	62	52	52	52	52	60	60	55

INSURANCE GROUPS	1.6 Man	1.8 Man	2.0 Man	T5	1.6D Man	1.6D DRiVe Man	2.0D	D5	1.8F Flexifuel Man
R-DESIGN Sport	7E	9E	12E	16E	8E	-	12E	14E	9E
R-DESIGN SE Sport	-	9E	12E	16E	-	-	12E	14E	-
S	-	-	-	-	-	8E	-	-	-
SE	7E	9E	12E	-	-	8E	12E	14E	9E
SE Lux	-	9E	12E	-	-	9E	12E	14E	-

E = Exceeds security requirements for model concerned and group rating has been reduced.

WEIGHTS	1.6 Man	1.8 Man	2.0 Man	T5		1.6D Man	1.6D DRiVe Man ^(vi)	2.0D		D5		1.8F Flexifuel Man
				Man	Gt			Man	P/shift	Man	Gt	
Min. kerb weight, kg (actual kerb weight dependent on spec.)	1289	1343	1339	1448	1459	1381	1385	1425	1449	1478	1494	1345
Max. possible towing weight braked, kg	1200	1300	1350	1500	1500	1300	N/A	1500	1500	1500	1500	1300
Max. towing weight unbraked approx. kg ^(v)	600	650	650	700	700	650	N/A	700	700	700	700	650
Max. towball weight, kg	75	75	75	75	75	75	N/A	75	75	75	75	75
Max. total weight, kg	1700	1750	1750	1860	1860	1780	1780	1840	1840	1900	1900	1750
Max. roofload, kg	75	75	75	75	75	75	75	75	75	75	75	75
Max. payload, kg (dependent on spec.)	411	407	411	412	401	399	395	415	391	422	406	405

LUGGAGE COMPARTMENT	All models
Volume, litres	433
Volume, rear seats down, litres	947

POWER STEERING SYSTEM	16"	17"	18"
(rack & pinion)			
Turning circle, m (ft)	10.6 (34.9)	10.6 (34.9)	11.6 (38.1)

BRAKES	1.6/1.8/2.0/1.6D/1.6D DRiVe/2.0D/1.8F	T5/D5
Disc diameter front, mm	15" - 278 Ventilated	16" - 300 Ventilated
Disc diameter rear, mm	280	280

TRANSMISSION	
Manual 2.0D/T5/D5	6 speed
Manual 1.6/1.8/2.0/1.6D/1.6D DRiVe/1.8F	5 speed
Geartronic T5/D5	5 speed
Powershift (Automatic Gearbox) (2.0D)	6 speed

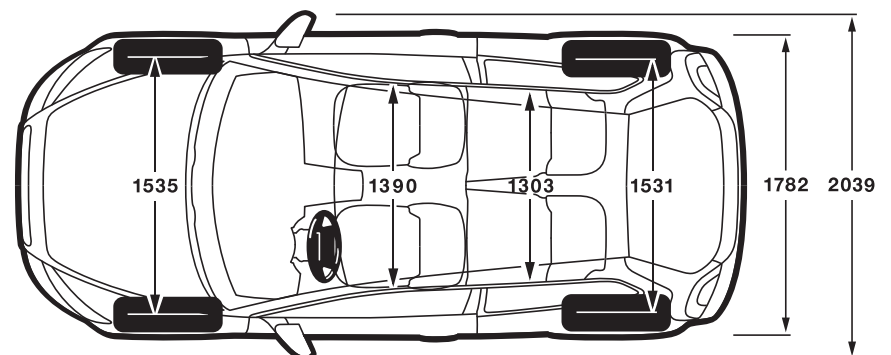
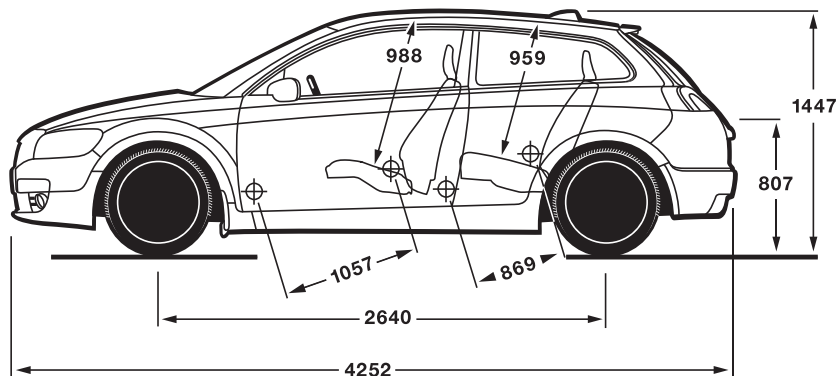

- (i) For best performance and lowest fuel consumption 98 RON is recommended, 95 RON can be used for normal driving.
- (ii) The results do not express or imply any guarantee of the fuel consumption of a particular car.
- (iii) Official fuel consumption figures are obtained in accordance with Directive 93/116/EC as amended by 1999/100/EC. The figures are obtained under controlled test conditions and as such consumption achieved on the road will not necessarily accord with the official test results. Factors including driving styles and road, car and weather conditions will also have a bearing on actual fuel consumption achieved.
- (iv) CO₂ and fuel consumption is based on petrol operation.
- (v) Unbraked towing weight must not exceed 50% of kerb weight up to a maximum of 700 kg.
- (vi) Not possible to fit Accessory Towbar on 1.6D DRiVe due to fitment of rear deflector.

Notes

The weight of a vehicle will influence the level of CO₂ emitted. As a result, vehicles with higher levels of specification and factory fit options may emit higher levels of CO₂. Once a vehicle has been built it will be given its own specific CO₂ emission on which the Vehicle Excise Duty will be charged.

A weighbridge must be used to determine specific weights. Data valid for manual transmission unless specified.

All measurements in mm.

Gt = Geartronic Automatic Transmission.

P/shift = Powershift Automatic.

The Max. output figures are quoted in PS (Pferdestärke), which is the metric equivalent of brake horsepower.

NB Some of the information in this price list may not be correct due to product changes which may have occurred since it was printed. Some of the equipment described or shown may now be available only at extra cost. Before ordering, please ask your Volvo dealer for the latest information. The manufacturer reserves the right to make changes at any time, without notice, to prices, colour, materials, specifications and models.

Volvo Car UK Limited, Globe Park, Marlow, Buckinghamshire, SL7 1YQ.

Accessories from Volvo

Of course, your Volvo C30 won't be perfect until it's exactly how you want it. And that's why we offer a range of accessories so you can completely personalise your new car. **The prices quoted below exclude fitting costs and are correct at time of going to press** – please confirm the total cost with your local Volvo dealer.

ACCESSORIES	Basic £	VAT £	Rec Retail Price £
EXTERIOR			
Aluminium Bike Rack (down tube clamp)	£53.13	£7.97	£61.10
Bike Rack (towbar mounted and collapsible)	£190.65	£28.60	£219.25
Load Carrier – wing profile	£108.51	£16.28	£124.79
Roofbox – Sport Time 200 (440 litre volume) ⁽ⁱ⁾	£153.56	£23.03	£176.59
Ski/Snowboard Carrier with Sliding Rail	£67.32	£10.10	£77.42
Towbar – Detachable type with 13 Pin Electrics ^(iv)	£371.89	£55.78	£427.67
Rear Park Assist	£152.03	£22.80	£174.83
Front Park Assist	£145.07	£21.76	£166.83
Bumper Cover, rear bumper	£23.30	£3.50	£26.80
Dirt Cover, complete	£132.92	£19.94	£152.86
Dirt Cover, cable lock	£19.76	£2.96	£22.72
INTERIOR			
Garmin Portable Sat Nav	£310.64	£46.60	£357.24
Boot Mat – textile/rubber reversible	£74.52	£11.18	£85.70
Bluetooth® Hands Free System ...from	£173.67	£26.05	£199.72
iPod Interface ⁽ⁱⁱⁱ⁾	£238.30	£35.75	£274.05
USB Interface ⁽ⁱⁱⁱ⁾	£238.30	£35.75	£274.05
Combined USB/iPod Interface ⁽ⁱⁱⁱ⁾	£238.30	£35.75	£274.05
Rubber Floor Mats (set of four)	£42.09	£6.31	£48.40
Sunblind – rear compartment (3 pieces)	£36.81	£5.52	£42.33
CHILD			
Child Seat ISOFIX ⁽ⁱⁱ⁾	£127.40	£19.11	£146.51
Infant Seat ISOFIX ⁽ⁱⁱ⁾	£163.47	£24.52	£187.99
ISOFIX Frame	£94.63	£14.19	£108.82

(i) Other roofboxes available – please ask your dealer for details.

(ii) VAT on Child Seats is 5%.

(iii) USB and iPod Interface standard on Premium and High Performance Sound.

(iv) Towbars cannot be fitted to DRIVe vehicles.

For further information and a complete list of all Volvo Accessories, take a look at the Accessory website at www.volvocars.co.uk/accessories or visit your local Volvo dealer.

Try a C30 for yourself with Volvo Rental

Why not hire a Volvo C30 – or any other Volvo – from Volvo Rental? You'll be guaranteed to drive a Volvo prepared to the highest standards by your local Volvo dealer. Call 0800 400 430 for more information today.





The end is just the beginning

It's a simple idea; one point of contact for all your car ownership needs – whether it's about finding the right finance deal or who to contact in an emergency. To get the most out of owning your Volvo, trust Care by Volvo.

STARTING OFF ON THE RIGHT FOOT

You might be surprised how easy and flexible financing can be. Our range of finance, service and insurance options allows you to budget around one key factor – your lifestyle.

FINANCE

As part of Volvo, Volvo Car Finance has developed a series of funding plans that will provide you with maximum choice and flexibility when acquiring a Volvo®. For details of the current promotions available, please visit www.volvocars.co.uk/financepromotions

INSURANCE

Volvo Car Insurance is designed for Volvo drivers and because we know Volvos inside out, we can offer exactly the right tools and expertise, fitting only genuine Volvo parts by trained Volvo technicians⁽ⁱ⁾. Your Volvo will come with seven days drive away insurance, so you've already got peace of mind. Because Volvo drivers have an excellent reputation, we can also offer extensive cover at a reasonable price⁽ⁱⁱ⁾.

Call now for your insurance quote on **0800 238 239**, quoting reference BROCH.



WHAT NEXT? If you'd like to find out more about the range of products and services that make up Care by Volvo, the story continues at www.volvocars.co.uk. Alternatively you can contact your nearest Volvo dealer or request relevant brochures.

(i) Finance subject to status. Guarantees/indemnities may be required. Volvo Car Finance SL7 1YQ.

(ii) When using a Volvo approved Body and Paint repairer.

(iii) Volvo Car Insurance is underwritten by Royal & Sun Alliance Insurance plc (No. 93792). Registered in England and Wales at St Mark's Court, Chart Way, Horsham, West Sussex RH12 1XL. Authorised and regulated by the Financial Services Authority. For your protection telephone calls will be recorded and may be monitored. All benefits are subject to qualifying status, terms and conditions, cover level and underwriting criteria. Service and repair benefits are subject to being carried out by a recommended repairer.

MAKING LIFE EASIER

Owning a Volvo should be a safe and enjoyable experience. To ensure it stays that way, we're committed to providing you with the best in support for as long as you own one.

SERVICE PROGRAMME

Your Volvo dealer has the unique know-how to tailor a service programme according to Volvo's strict recommendations and guarantees you years of safety and driving pleasure.

VOLVO ON CALL

Subscribe to Volvo On Call and you'll never be completely on your own. It's a GPS-based communication system providing 24-hour access to both emergency and roadside assistance wherever you are. See the Volvo On Call brochure for more information.

LOOKING AHEAD

You'll probably never find out just how good some of these services are. But should the unexpected happen, we'd like to think that you'd be even happier you chose a Volvo.

ROADSIDE ASSISTANCE

Every new car comes with one year's Volvo Assistance cover. You'll enjoy free breakdown and recovery assistance, anywhere in Europe, 24 hours a day. You can even extend cover for £85 for one year or £155 for two years. Call Volvo Assistance on **08701 650 978**.

WARRANTY

Every new Volvo comes with comprehensive protection. Our warranty covers the first three years or 60,000 miles, whichever comes first. There's a three year unlimited mileage warranty on the paintwork, and either eight or twelve years against rust perforation. If a component fails due to a defect or material fault, your dealer will swiftly rectify the problem, free of charge.

Volvo. for life

For tax free sales, including Military, Diplomat and all other Export enquiries, contact Volvo Car UK Tourist & Diplomat Sales or Volvo Car UK British Military Sales on **01707 262 388** or e-mail to vcukics@volvocars.com or bms@volvocars.com

All 'On The Road' prices quoted in this price list include Volvo standard national delivery charge, inclusive of number plates and VAT at £520 and the VED (Vehicle Excise Duty) car tax as of 1st December 2008. This charge does not include any provision for fuel. The 'On The Road' price also includes a £55 vehicle first registration fee (as set by the government – excludes Channel Islands and Isle of Man). Recommended retail prices quoted do not include these additions.

NB Some of the information in this price list may not be correct due to product changes which may have occurred since it was printed. Before ordering, please ask your Volvo dealer for the latest information. The manufacturer reserves the right to make changes at any time, without notice, to prices, colour, materials, specifications and models.